

Experimental Techniques in Particle Physics

Prof. J. D'Hondt
Vrije Universiteit Brussel
jodhondt@vub.ac.be
Tel: 02-6293483
Office: Campus Oefenplein – 0G117



Vrije Universiteit Brussel

Content

Overview of a contemporary collider experiment

- I {
 - General timeline of a collision experiment (eg. LHC)
 - Overview of the structure of all systems in a detector
 - First layer of triggers to reduce the data stream to tape
 - Data Acquisition system & High Level triggers
- II {
 - Reconstruction aspects of tracks
 - Identification of specific objects (eg. b-tagging)
- III {
 - General analysis techniques to select the signal processes
 - Advanced statistical tools for measurements
 - An example analysis of how it all comes together...

It should take about 3 sessions of about 4 hours on average to cover the course. This will be complemented with a reading exercise with a written report by the students (this is part of the exam).

The first part

General concepts of triggering and DAQ

- Introduction to high energy physics (HEP) – *short!*
 - Theory evolution & experiments evolution (accelerators)
 - Evolution of particle detectors (rate of particles produced in collisions)
- General timeline of a collision experiment (eg. LHC)
 - From the design concepts to the final paper
 - Introduction to the Large Hadron Collider at CERN
- Overview of the structure of all systems in a detector
 - Complexity of a particle detector (eg. Compact Muon Solenoid)
 - General layout of a Trigger & Data Acquisition (DAQ) system
- First trigger layer to reduce the data stream to tape
 - Hardware based trigger setups & performance
- Data Acquisition system & High Level Triggers
 - Read-out of the detector & event building
 - Final trigger level algorithms

Introduction to HEP

- The basic goal of the field of High Energy Physics is to reveal the fundamental particles in Nature and the interactions among them.
- It aims to construct a formal theory which allows to predict the outcome of interactions via perturbative calculations (matching general relativity and quantum mechanics in a quantum field theoretical approach).
- The domain covers a wide range of experiments of which some have a close connection to the fields of astronomy and cosmology. Due to the complexity of most particle detectors and accelerators the domain is a driving force for technology.

Evolution of the theory

- Today we know the Standard Model as a solid theory of particle physics putting the Electro-Weak and Strong force within one framework in a Quantum Field Theory.
- This model (which is basically a theory) has been the result of many experimental observations over the last ~ 50 years at for example fixed target experiments and collider experiments.
- To validate the Standard Model we aim to observe phenomena at always higher energy densities and we aim to measure its parameters as precise as possible.
- To achieve this we need accelerators which are as powerful as possible and detectors which can measure as precise as possible, hence driven the technology on different sides.
- One of the open questions we have today is the apparent dominating Dark Matter in the Universe for which the Standard Model particles cannot give an answer.

Timeline of a HEP experiment

The idea of a new laboratory is motivated by the need to investigate yet unexplored domains either in energy, in rate, in flavour, in exposure time, etc.

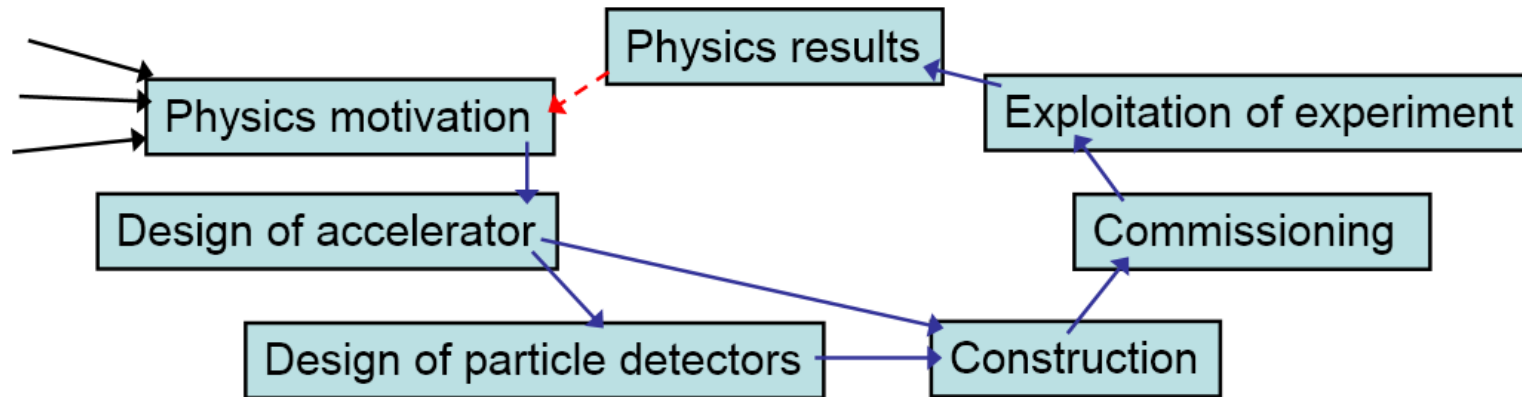

Usually theory motivates that new phenomena are to be discovered in this new domain or that the measurement of specific phenomena will give us much more insight in the current theories

Evolution of the experiments

In general new particles and phenomena are being discovered or measured at particle accelerators.

In general several types of collision experiments exist:

- Fix target experiments (eg. discovery of the quarks – proposed by J.Björken – within the proton/neutron at SLAC in 1969)
- Synchrotron experiments with colliding lepton beams (eg. LEP where electrons and positrons collided 1989-2000)
- Synchrotron experiments with colliding hadron-lepton beams (eg. HERA where electrons and protons collided 1993-2007)
- Synchrotron experiments with colliding hadron-hadron beams (eg. Tevatron at Fermilab & LHC where protons will be collided 2009-?)
- Linear colliders where leptons are colliding (eg. SLC where electrons and positrons collided 1989-1998)

Usually it takes a sequence of several experiments to reach the goal of testing the Standard Model or other theories profoundly.

Generalities of accelerators

The main parameters of an accelerator are (those relevant for this course):

- the maximum beam energy & the dipole field for circular accelerators
- the luminosity

$$\text{Rate} = \sigma \mathcal{L}$$

σ - **cross-section** (units of cm^2 or barn= 10^{-28}cm^2), probability that an interaction will occur. If this were a game of darts, the larger the area of the dart board the more likely you will get the dart on the board.

\mathcal{L} - **luminosity** (units of $\text{cm}^{-2}\text{s}^{-1}$ or barn $^{-1}\text{sec}^{-1}$), cross sectional density of the beams. The more particles per beam or the more compact (transverse) the higher the luminosity. For colliding beam, goes as the product of the two beam currents.

- the time between collisions
- the bunch length
- particles per bunch & number of bunches per ring

The luminosity (hence the event rate) at colliders has increased by large factors.

Evolution of these parameters



	LEP2 (ee)	HERA (ep)	Tevatron (p-antip)	LHC (pp)
Beam energy (GeV) X	~100	~30 (e) ~920 (p)	~980	~7000
Dipole field (Tesla)	0.135	0.274 (e) 5 (p)	4.4	8.3
Luminosity ($10^{30}\text{cm}^{-2}\text{s}^{-1}$) X	100	75	171	10000
Time between collisions (ns) X	22000	96	396	25
Bunch length (cm)	1.0	0.83 (e) 8.5 (p)	50	7.55
Particles per bunch (10^{10})	45	3 (e) 7 (p)	24 (p) 6 (antip)	11.5
# bunches	4	189 (e) 180 (p)	36	2808

Evolution of accelerator types

Hadron colliders can go higher in energy with the same technology compared to lepton colliders. This is due to the energy loss in synchrotron radiation when charged particles curve (hence electromagnetic radiation generated by the acceleration of ultra-relativistic charged particles through magnetic fields)

- energy loss per turn $\Delta E \sim E^4/(r m^4)$
- E is the energy of a particle with mass m which described a circle with radius r
- the mass of a proton is 2000 times larger than that of an electron.

Hadron colliders can reach higher energies with the same electric RF fields compared to leptons, hadron colliders are therefore used to explore a new energy regime but lepton colliders are used to perform precise measurements.

SPS (discovery W/Z bosons) → LEP (measurement W/Z bosons)
LHC (discovery of SUSY ?) → ILC (measurement of SUSY ?)

Evolution of accelerator types

- Hadron colliders reach higher beam energies compared to lepton colliders, but the partons within the hadrons which collide have only a fraction of the beam energy. The leptons carry the full beam energy.
- Strong progress over the last decades in accelerator performance, but slowed down recently due to the scale of the projects and no real revolution in the technology which is being applied.

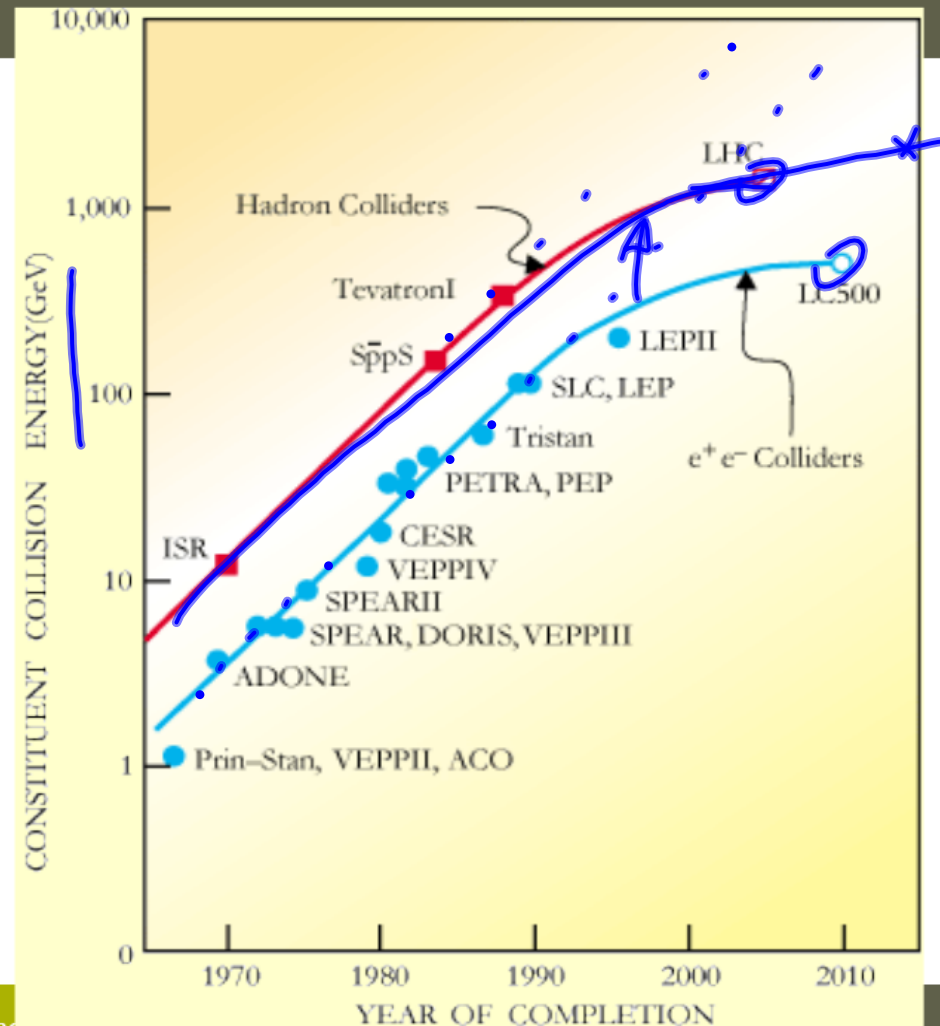

Evolution of the detectors

Particle detectors have been evolving from simple devices with few channels to very complex multi-layer systems with several millions of read-out channels.

- the data acquisition (DAQ) systems have evolved accordingly
- the main reason for this evolution is the ever increasing particle rate in the final state of the collisions we provoke in the laboratory
- together with the usually custom detector electronics

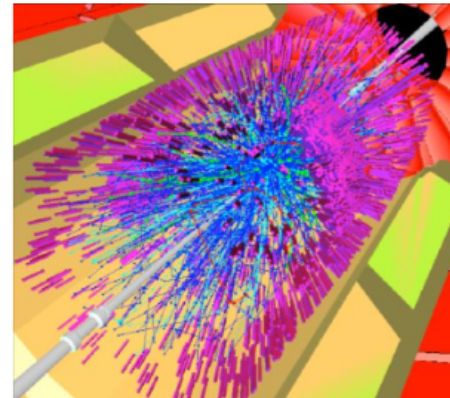

More events to be looked at in less time and also more complex events, give stronger requirements on the read-out and trigger systems of our detectors.

Event rate at early experiments

- Bubble Chambers, Cloud Chambers, etc. (4π)
 - DAQ was a stereo photograph!
 - Effectively no Trigger:
 - Each expansion was photographed based on the accelerator cycle
 - The High level trigger was human (scanners).
 - Slow repetition rate.
 - Only most common processes were observed.
 - Some of the high repetition experiments (>40 Hz) had some attempt at triggering.
- Emulsions still used in some neutrino experiments (eg CHORUS, DONUT).

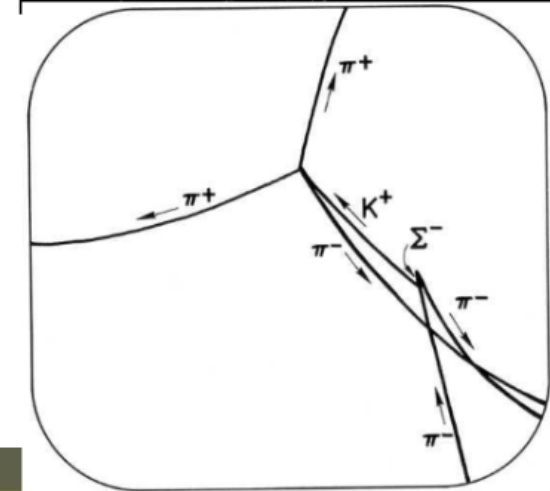
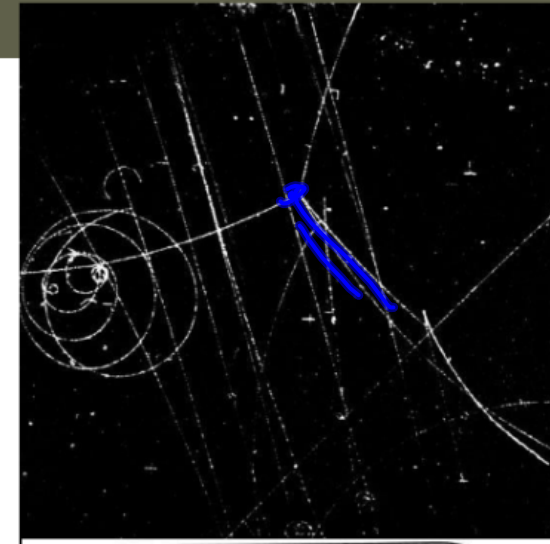

Data Acquisition

Data acquisition systems in general obtain information of a physical property, usually multi-dimensional, from the signals of detectors. Hence the system contains electronic components which can convert specific measured parameters into an electrical signal. The acquired data is hereafter stored on a disk for further analysis by a computer. The DAQ hardware are electronic devices which provide an interface between the signal and the computer.

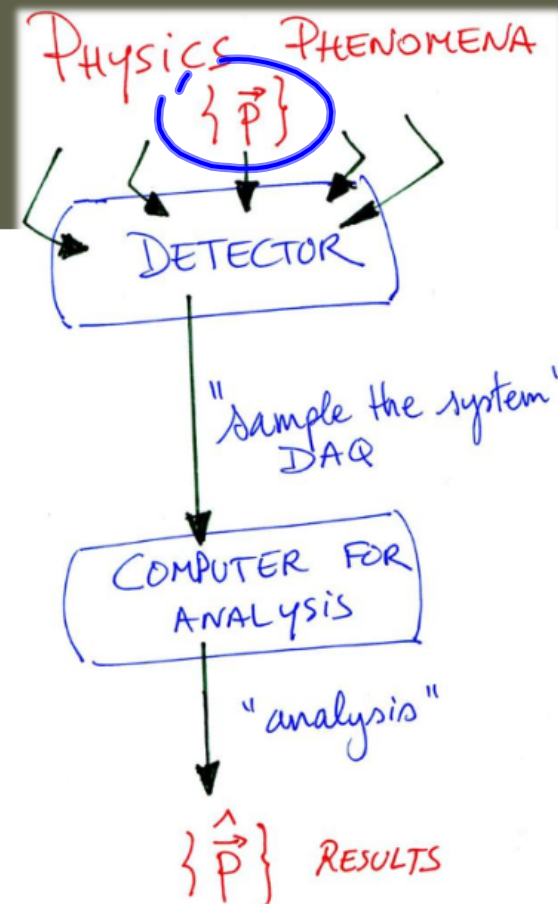

In the language of HEP experiments, the DAQ system collects the signals of the millions of detector channels and allows the trigger system to analyze the data stored.

Electronic signals (reminder)

The signal is in most cases a short voltage pulse... how does this look like?
 First some basics:

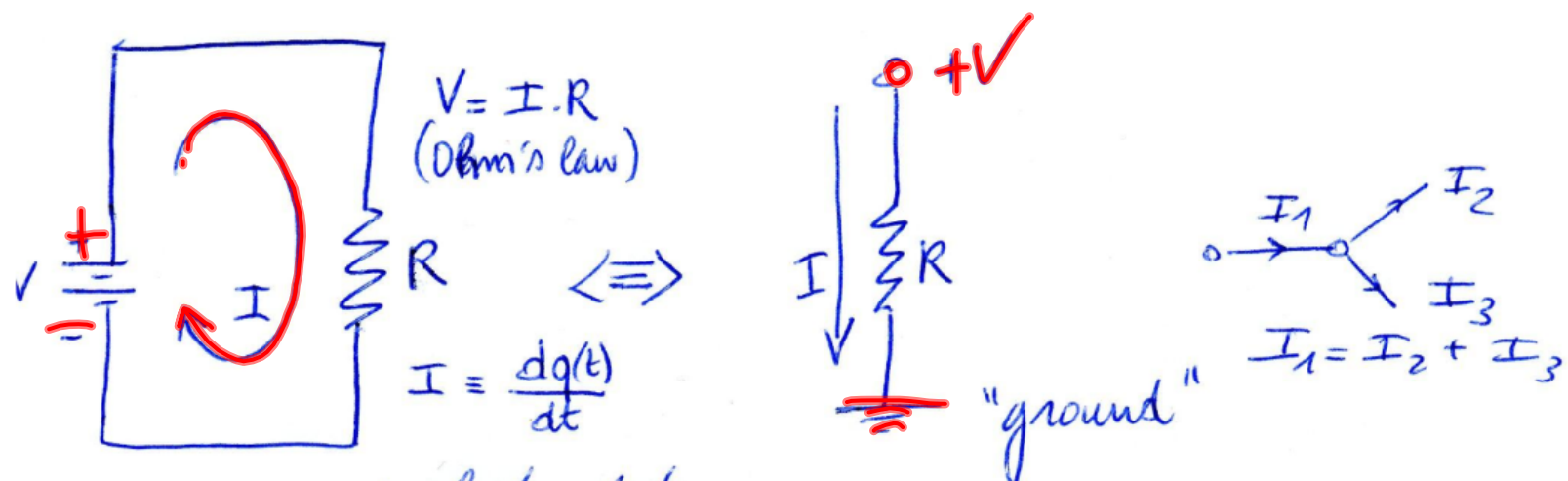

→ equivalent notation
 Only the relative voltage between points matters
 ⇒ all relative to the "ground"

Electronic signals (reminder)

Resistors :



$$R = R_1 + R_2$$

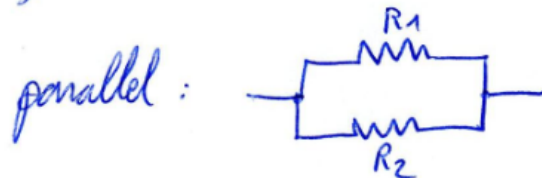

$$\frac{1}{R} = \frac{1}{R_1} + \frac{1}{R_2}$$

from }
$$\begin{aligned} IR &= I_1 R_1 = I_2 R_2 \\ I &= I_1 + I_2 \end{aligned}$$

Capacitors (stores charges, but no charges go through it)

$$C \equiv \frac{q}{V} \rightarrow \frac{\text{"charges stored"}}{\text{"potential difference"}}$$

serie :
$$\frac{1}{C} = \frac{1}{C_1} + \frac{1}{C_2}$$

parallel :
$$C = C_1 + C_2$$

} inverse behaviour of R
due to Ohm's law

Electronic signals (reminder)

Assume voltage change with time (AC circuit)

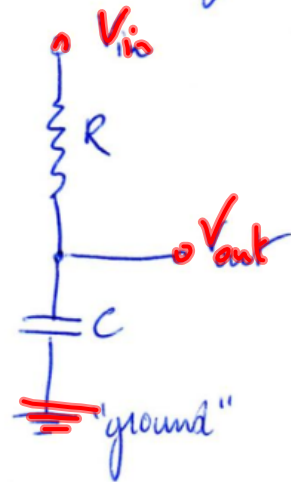

$$V_{in}(t) = \begin{cases} 0 & t \leq 0 \\ V & t > 0 \end{cases}$$

(no change on capacitor at $t=0$)

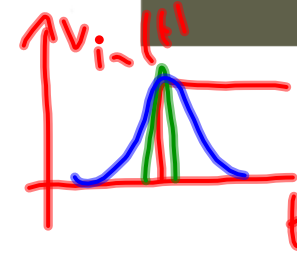

$$\begin{cases} V_{out}(t) = \frac{q(t)}{C} & \text{"voltage drop capacitor"} \\ IR = \frac{dq(t)}{dt} \cdot R & \text{"voltage drop resistor"} \end{cases}$$

$$q(t) = C \cdot V_{out}(t)$$

$$\Rightarrow V = V_{out}(t) + \frac{dq(t)}{dt} \cdot R$$

$$\Rightarrow V_{out}(t) + R \cdot C \frac{dV_{out}(t)}{dt} = V$$

Solution of this differential equation: $V_{out}(t) = V \cdot (1 - e^{-t/RC})$

In real life the voltage at the input has some distribution and will appear only for a short period.

→ Fourier analysis (cfr. other courses)

Electronics

The signal appears as a peak in the time-dependent voltage evolution:

$$V_{out}(t) = \int_{-\infty}^t V_{in}(t') \frac{\exp(-\frac{t-t'}{RC})}{RC} dt'$$

with $V_{in}(t')$ a gaussian function σ

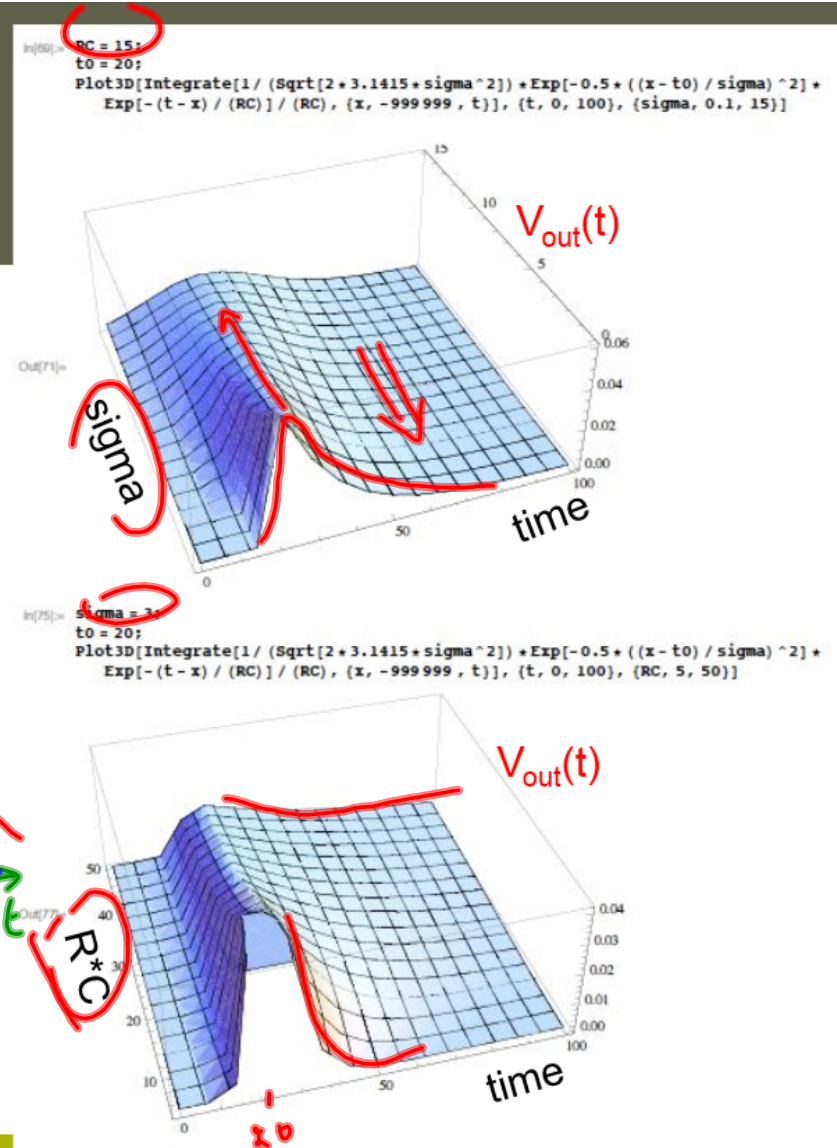
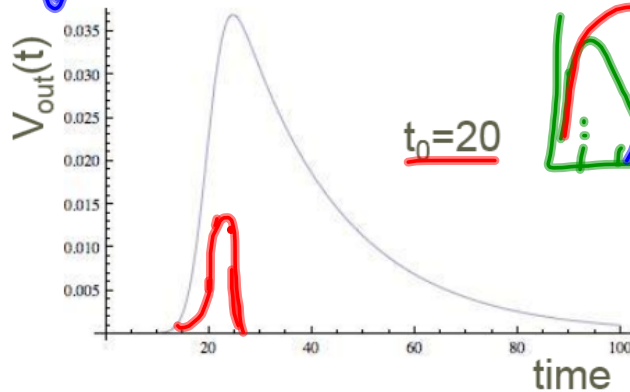

Cross section & event rate

- The cross section of specific processes is changing when going to higher energies.
- The total cross section in hadron collisions is increasing according to the measurements made (extrapolation to higher energies).
- Together with the luminosity increase this results in a higher event rate $R = \mathcal{L} \sigma$, hence important technical challenges for the design of the experiments.

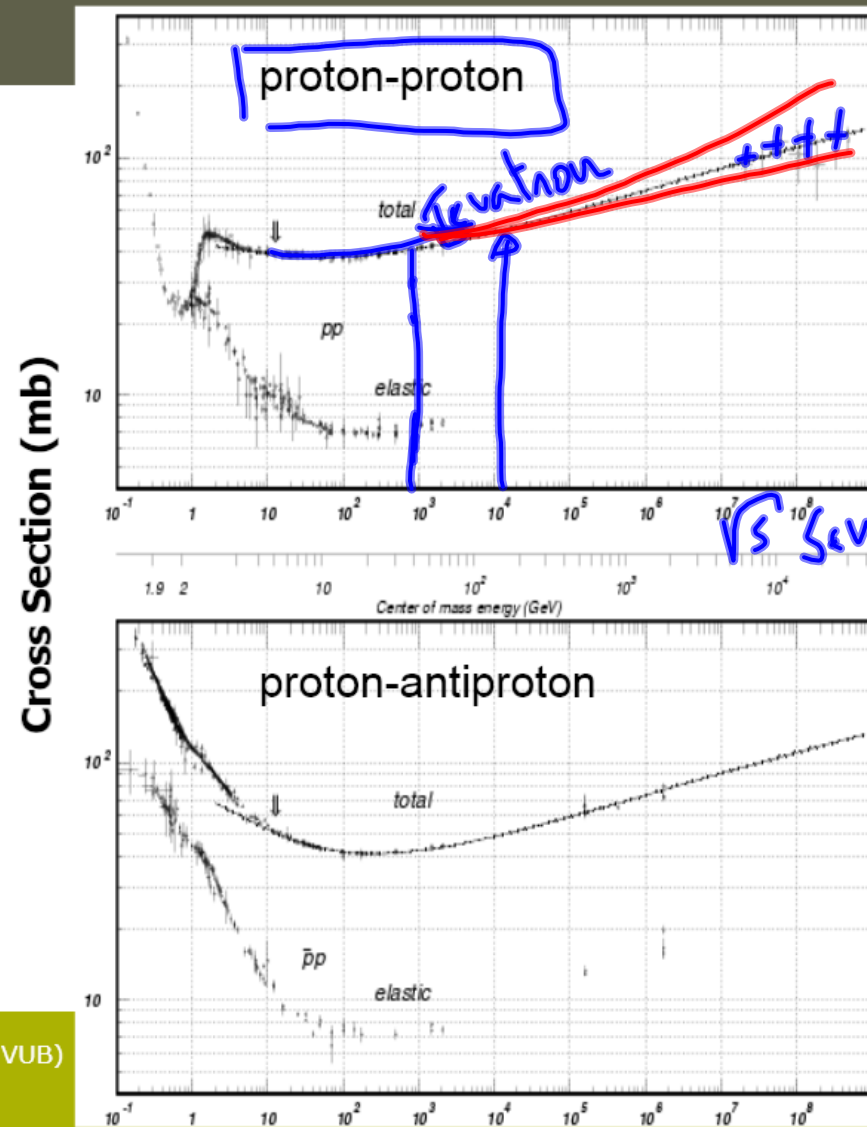

Cross section & event rate

- The total cross section at the LHC (14 TeV) ranges between 90 and 130 mb

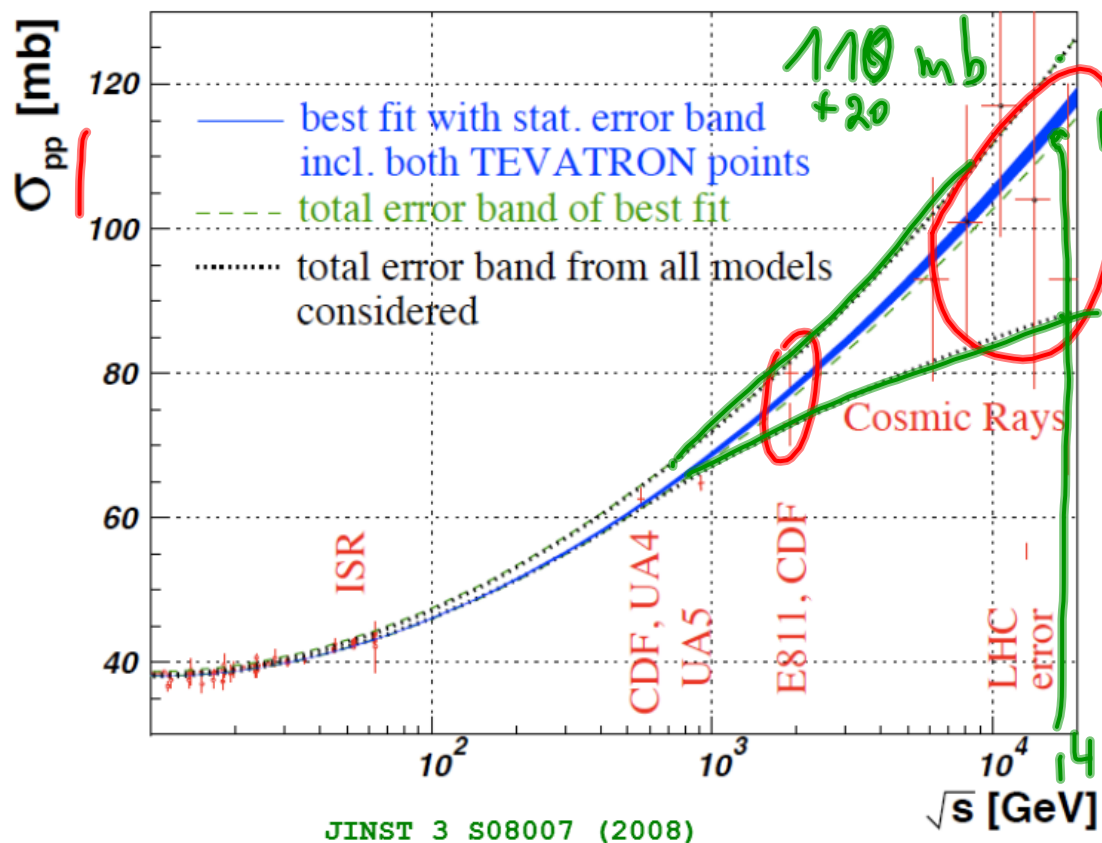

1 bpsing = 1 MB 40 MHz \Rightarrow 40 TB/yr
 40,000,000
 Cross section & event rate

- In general the cross sections of Standard Model processes is increasing when going to higher centre of mass energies.
- The processes of interest to be discovered (Higgs bosons, SUSY, etc.) have much lower cross sections compared to the Standard model processes, but as they require the creation of particles at higher mass scales they usually increase more rapidly compared to Standard Model processes with the centre of mass energy.

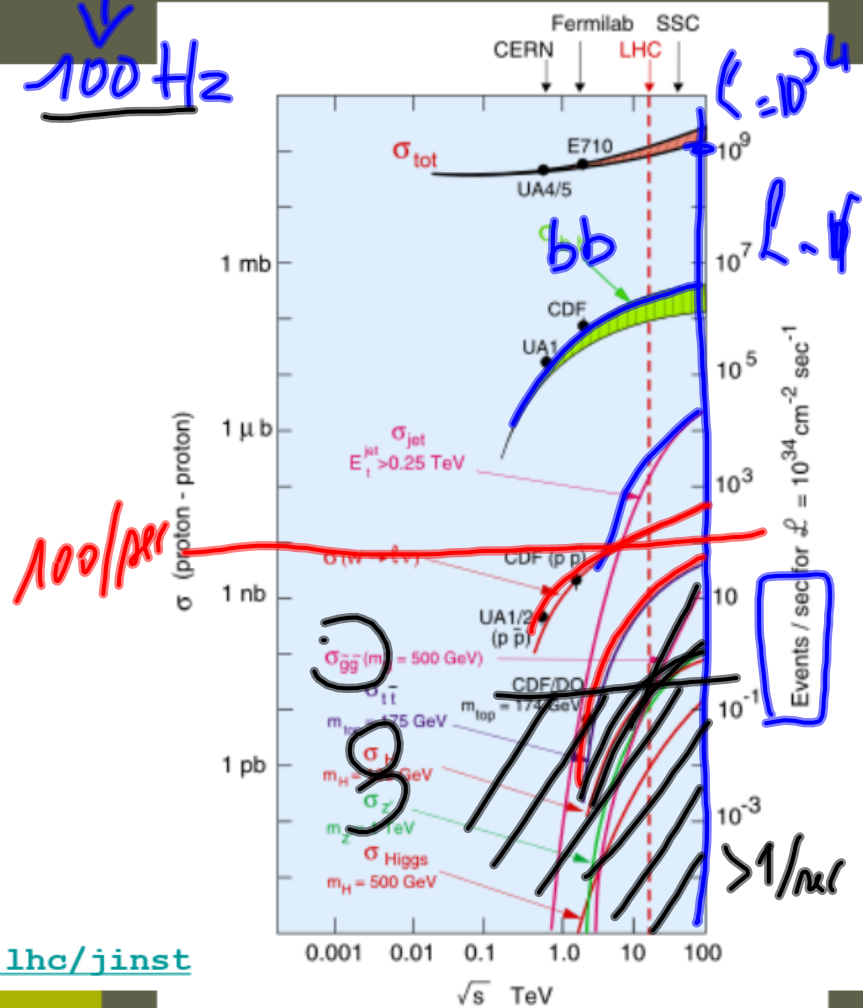

References for LHC & experiments:
<http://www.iop.org/EJ/journal/-page=extra.lhc/jinst>

Goal of the trigger setup

- Goal of Trigger and DAQ systems is to store the maximize amount of data for the desired process with minimal cost (=time)
- Relevant efficiency is for events that will be useful for later analysis
- Low rate process (eg. Higgs production at Tevatron or LHC), try to accept them all in the trigger, hence maximize their selection efficiency.
- Dead-time induced do to fluctuations when rate into a stage of trigger (or read-out) approaches the rate it can handle.

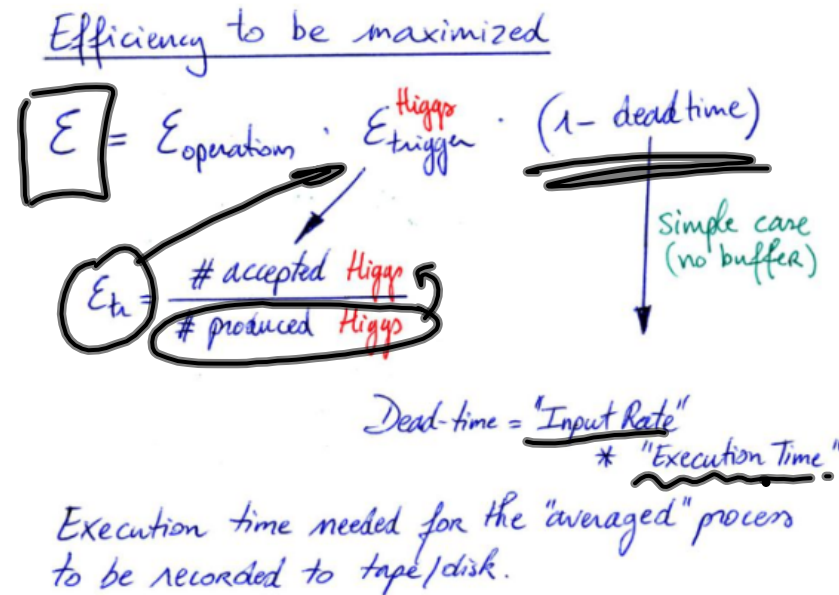

Buffering incoming data reduces dead-time, more buffering less dead time

- If $\langle \text{Incoming Rate} \rangle$ is larger than $1/\langle \text{Execution Time} \rangle$, dead no matter what!

Minimizing dead-time helps all processes

- 1% of machine time * 1 year = exploitation time lost (=money lost)

Trigger on what? SM

Accept specific decays modes

- high P_T leptons from W, Z, top, W/Z+Higgs QCD: High Et jets
- $B_s/\psi \rightarrow \mu\mu$, medium p_T leptons for B physics

Reject:

- lower P_T objects (QCD)

Select on object/event kinematics:

- ~~X~~ E_T of Calor Tower (cluster) or missing E_T
- ~~X~~ muon P_T (+ track P_T)
- track P_T (+ impact parameter/detached vertex)

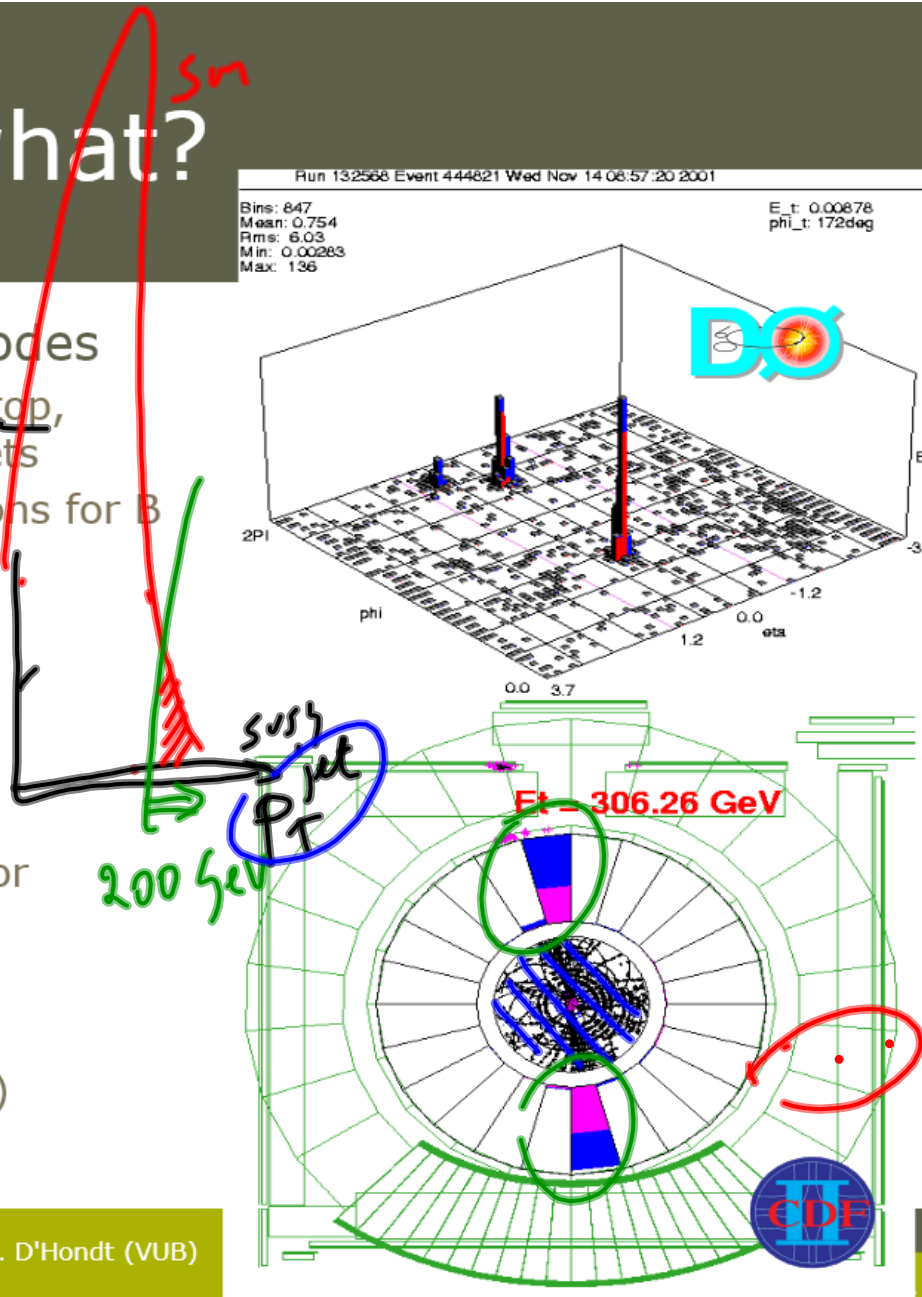
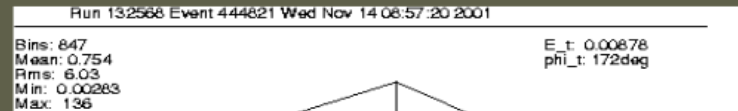

Hadron collisions

What do you expect to see in the detector?

Warning: simplified schematic view which is not to scale



The incoming particles are contained into bunches of for example 10^{11} hadrons (eg. protons). The proton is a bag full of partons which have probability densities depending on Björken- x (longitudinal momentum fraction) and the Q^2 (momentum transfer), hence the partons collide with each other, not the full hadron.

Hadron collisions

What do you expect to see in the detector?

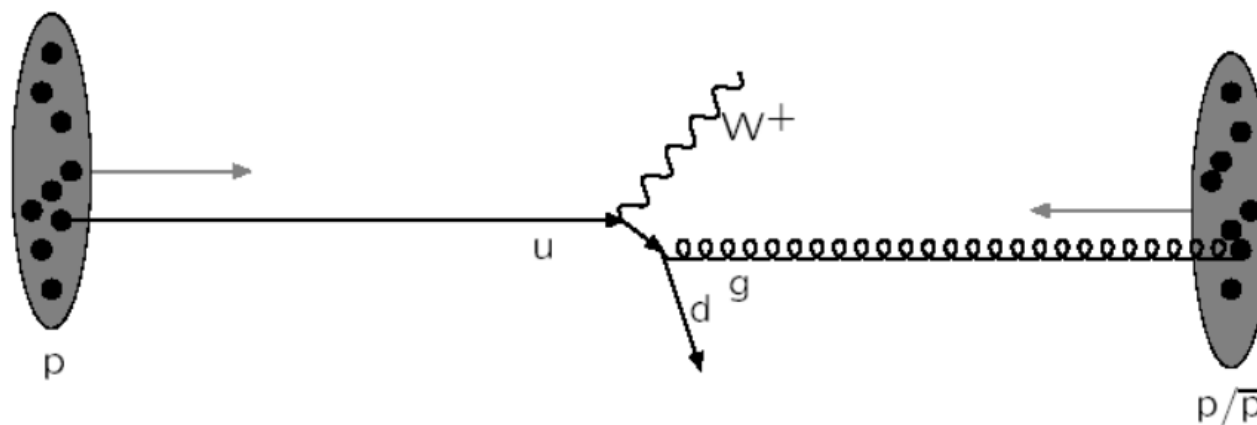

The partons (being quarks or gluons) interact reflecting the hard subprocess described by matrix elements obtained from quantum field theory calculations (Feynman diagrams).

Hadron collisions

What do you expect to see in the detector?

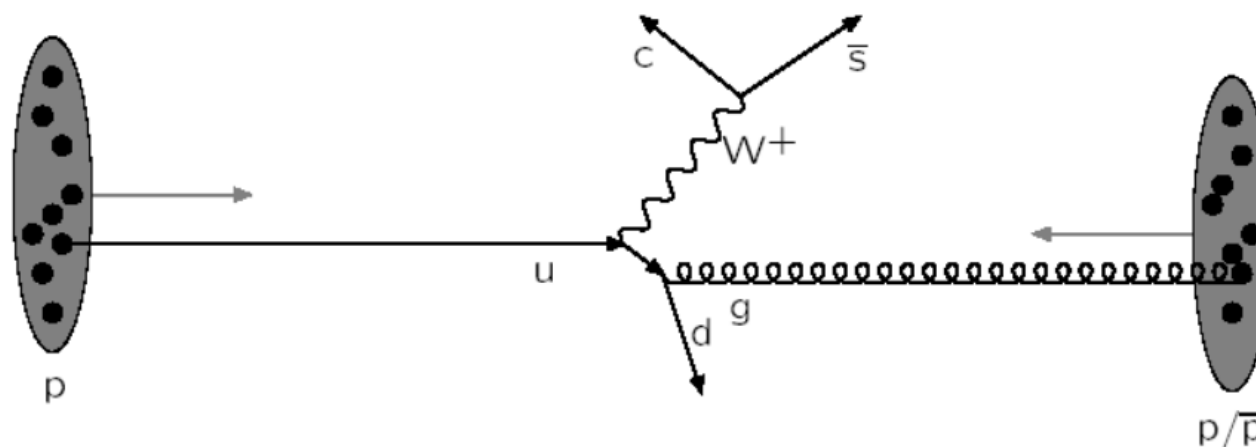

The heavy resonances decay, for example the W boson with a mass around 80 GeV. This is still correlated with the hard subprocess and is usually calculated with the same tools.

Hadron collisions

What do you expect to see in the detector?

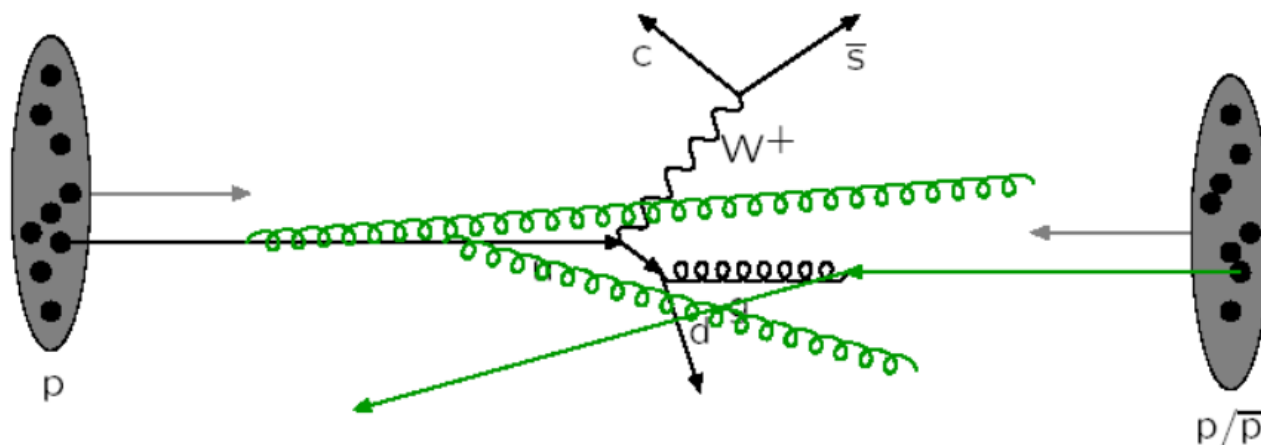

The partons could radiate coloured particles before interacting with each other, this is called initial state radiation (=space-like parton showers).

Hadron collisions

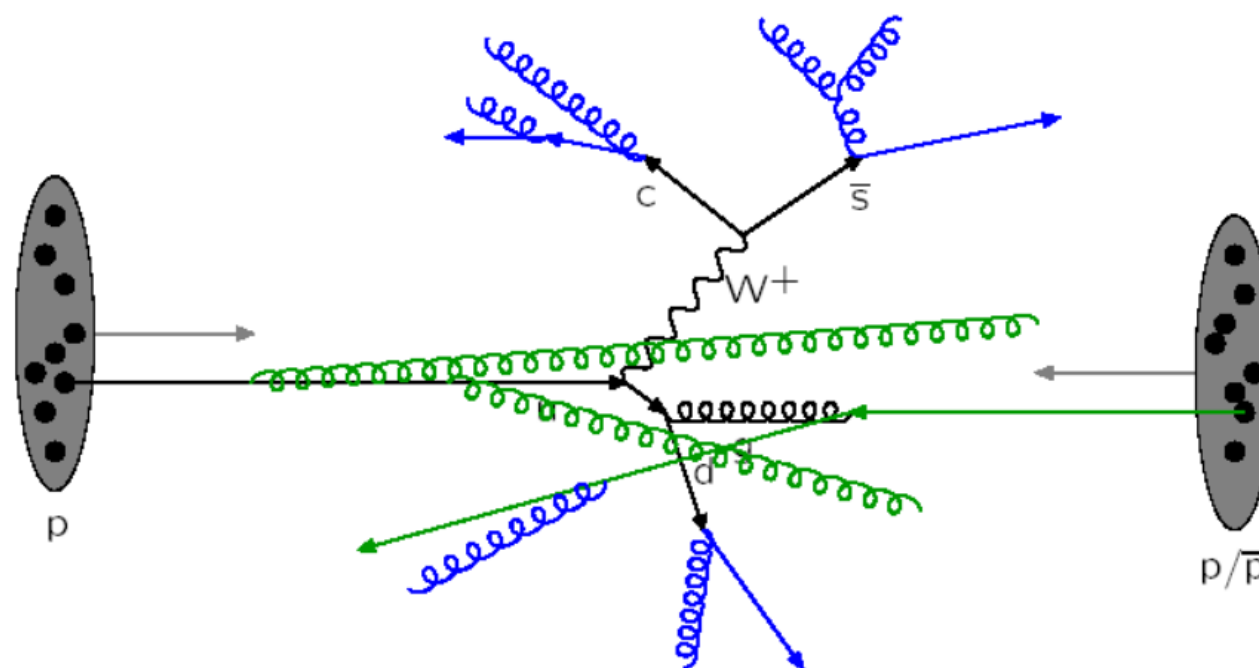

The partons could radiate coloured particles after interacting with each other, this is called final state radiation (=time-like parton showers).

Hadron collisions

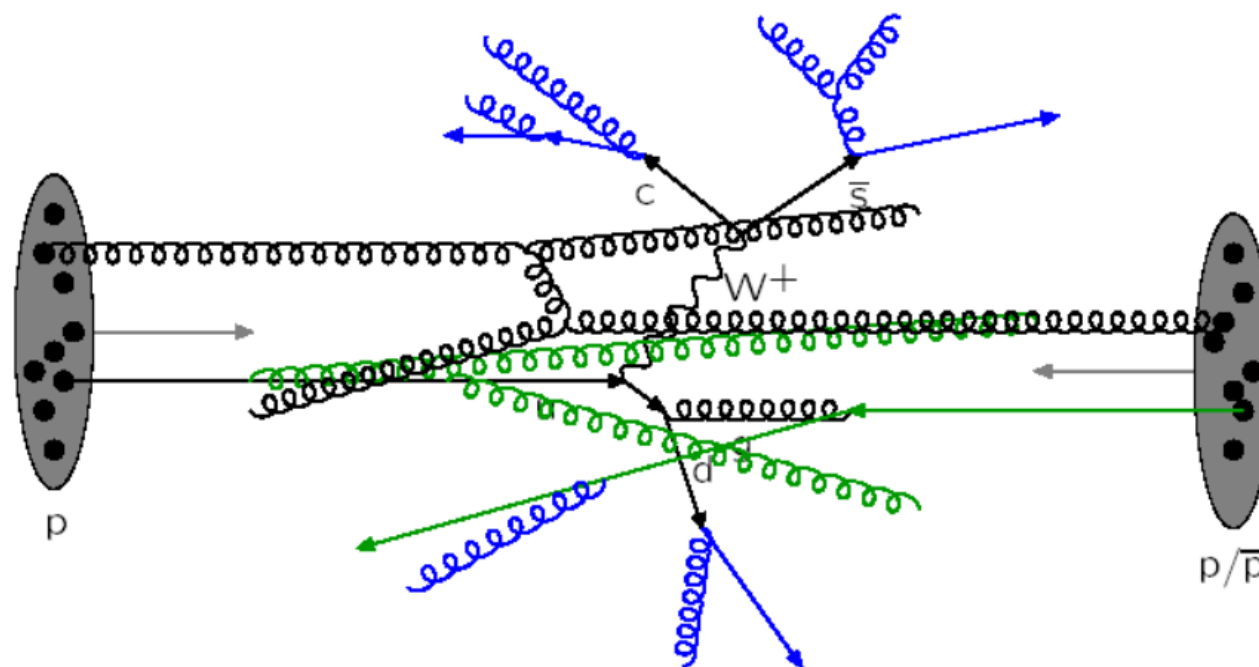

The hadrons consist out of several partons, hence there can be more than one parton-parton interaction. We speak about multi-parton interactions.

Hadron collisions

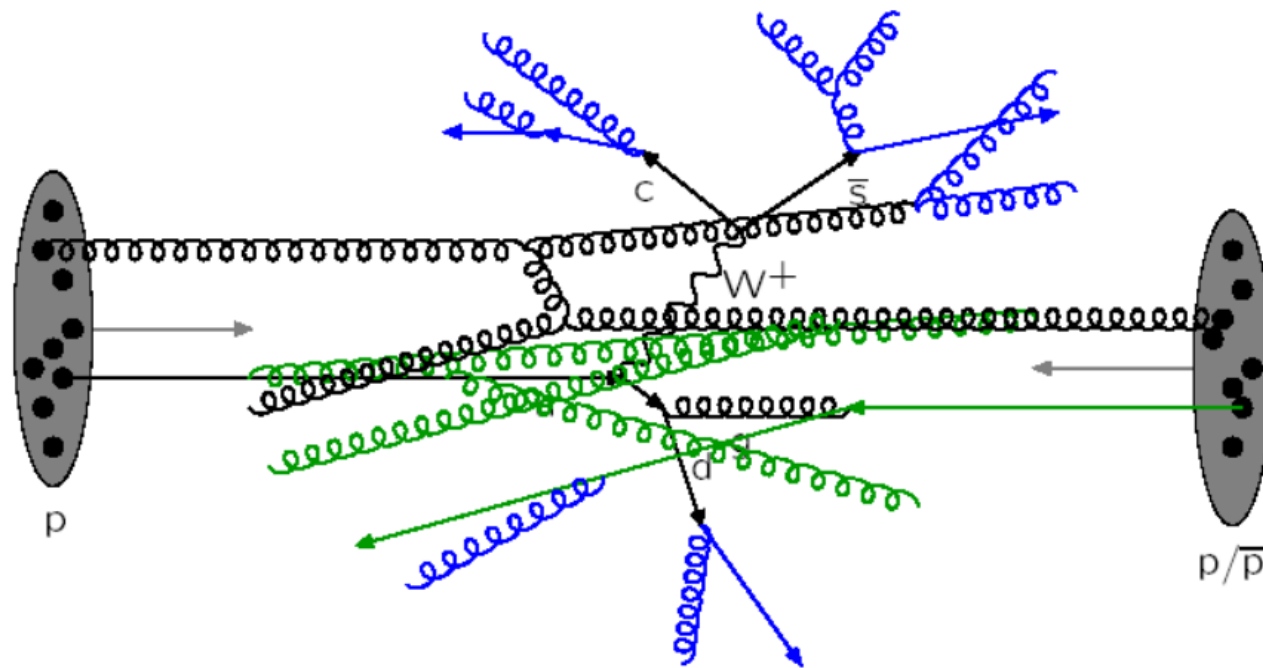

And in these extra parton-parton interactions there can also be initial and final state radiation of extra partons. More blue and green lines...

Hadron collisions

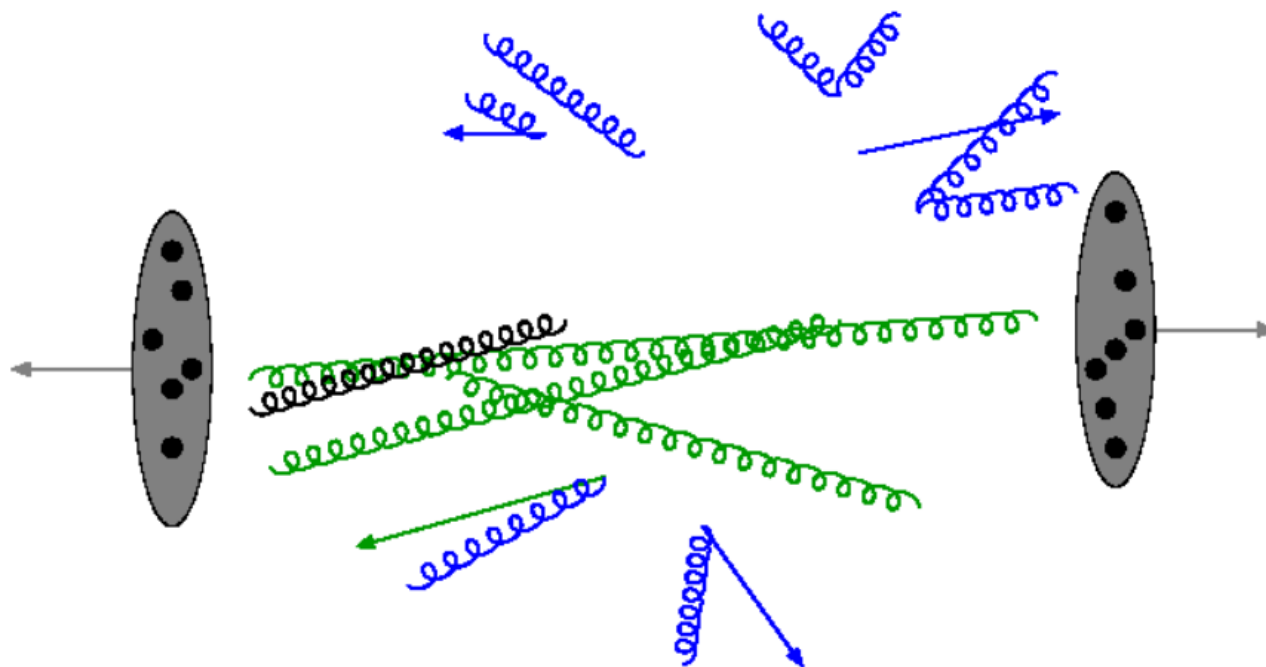

After the collision of course we do not “see” the internal lines, we only “see” the outgoing partons and the beam remnants.

Hadron collisions

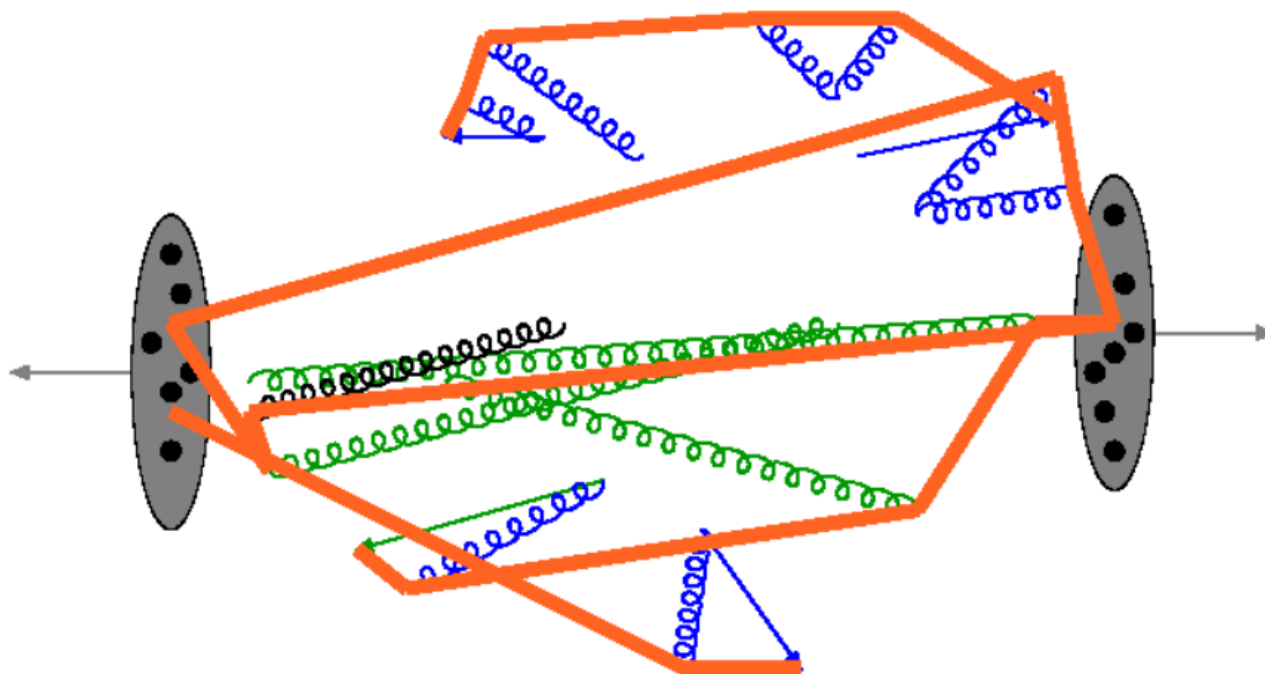

All partons are connected by colour confinement strings (colour field between partons as you have an electromagnetic field between charged particles).

Hadron collisions

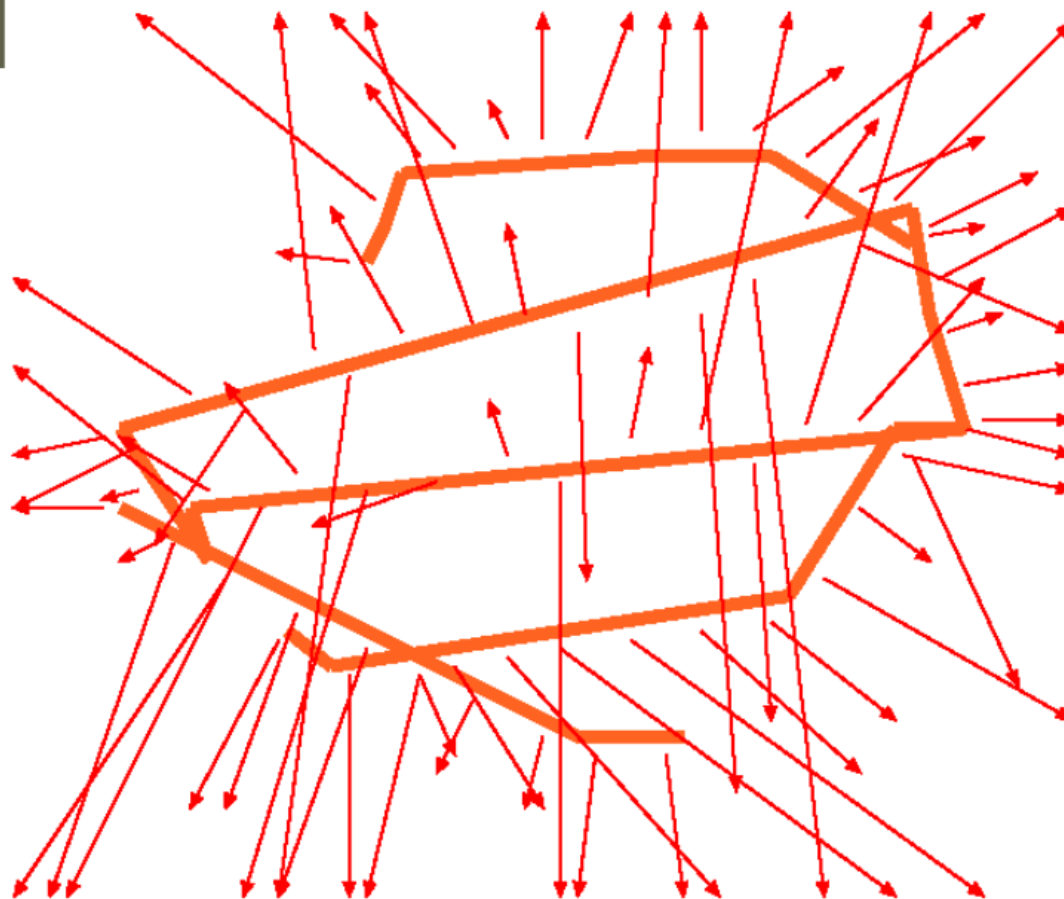

The strings will fragment to produce in general hadrons, hence colour-neutral particles.

Hadron collisions

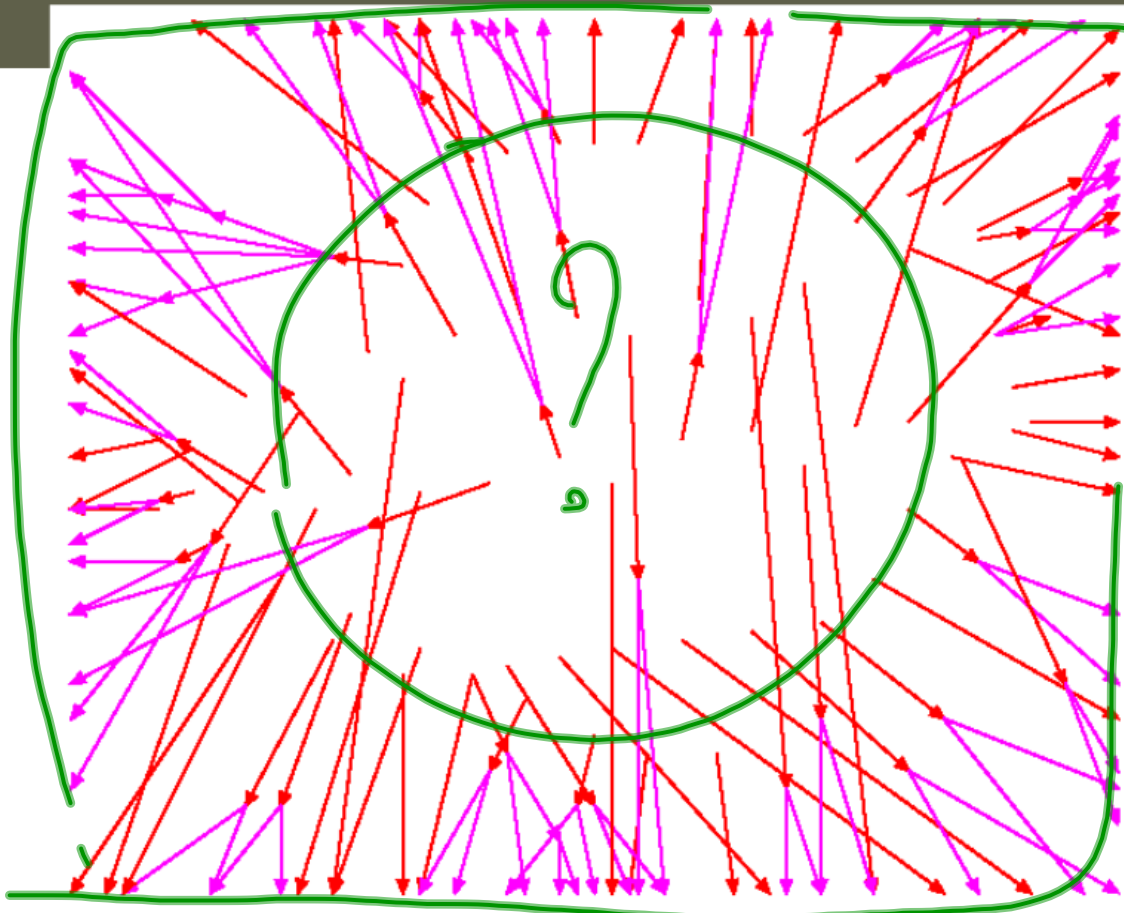

A lot of hadrons are not stable and will decay further into stable particles which we will observe in our detectors.

The Large Hadron Collider (LHC)

The next in line accelerator is the Large Hadron Collider at CERN which collides protons up to centre of masses of 7-14 TeV

Several theory based motivations are driving the design of both the accelerator and the particle detectors

- Search for the Higgs boson motivated by the spontaneous symmetry breaking mechanism [Brout, Englert, Higgs] and the divergences of cross section of the $WW \rightarrow ZZ$ scattering process
- Or alternative models explaining the origin of mass
- The search for particles able to solve the Dark Matter problem in the Universe, eg. by introducing Supersymmetry in our theories
- Try to incorporate gravity into the Standard Model
- Many exotics ...

The accelerator started in 2009

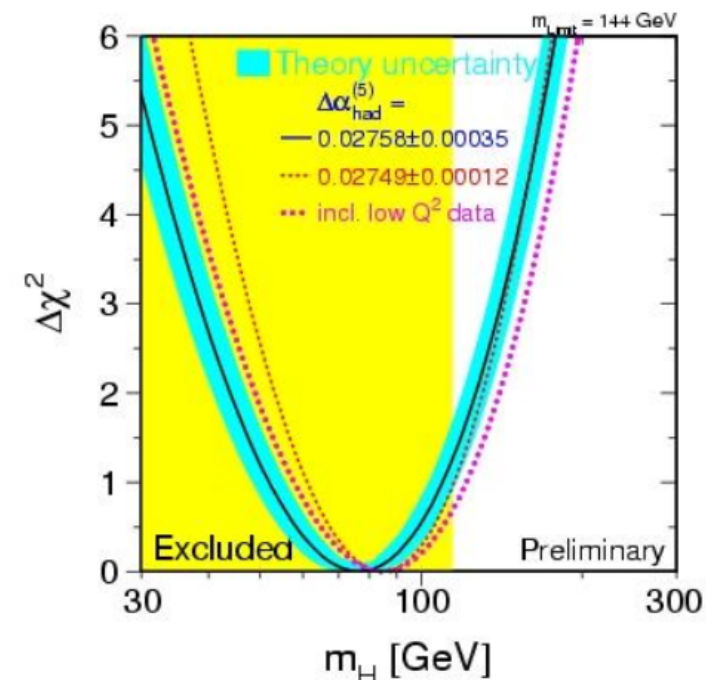

The timeline of the project

The history of this accelerator is long:

- 1982: first studies for the LHC project
- 1983: Z0 & W boson discovered at the SPS proton anti-proton collider
- 1989: start of LEP operation (Z boson factory)
- 1994: approval of the LHC by the CERN Council
- 1996: final decision to start the LHC construction
- 1996: LEP operation to produce W boson pairs (W boson factory)
- 2000: last year of LEP operation above 100 GeV beam energy
- 2002: LEP equipment removed
- 2003: start of the LHC installation
- 2005: start of LHC hardware commissioning
- 2008: LHC commissioning with beam (and incident with magnets)
- 2009: start of the accelerator at 900 and 2360 GeV
- 2010: run at 7 TeV

Large Hadron Collider basics

Colliding protons at the LHC $\sqrt{s} = 7-14$ TeV

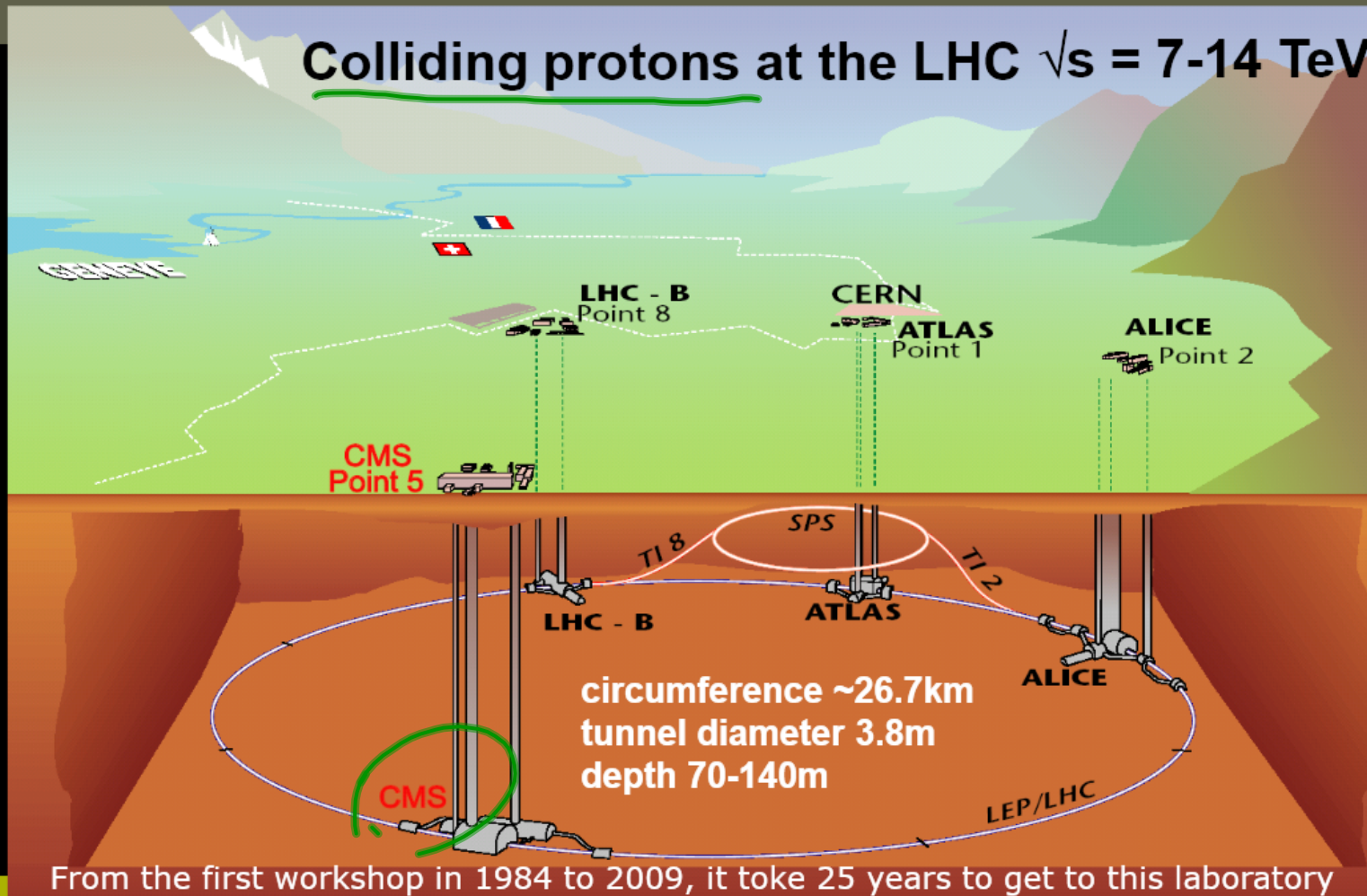

Laboratory is operational!



... new era for physics !

Higgs boson production at LHC

- How does the Higgs boson shows itself: several production and decay possibilities
- Would like to have 20-30 Higgs boson events per year at the highest masses (lowest cross section)
- Hence need $10^{34} \text{ cm}^{-2}\text{s}^{-1}$ of luminosity and ~ 2800 bunches in the 27km long accelerator

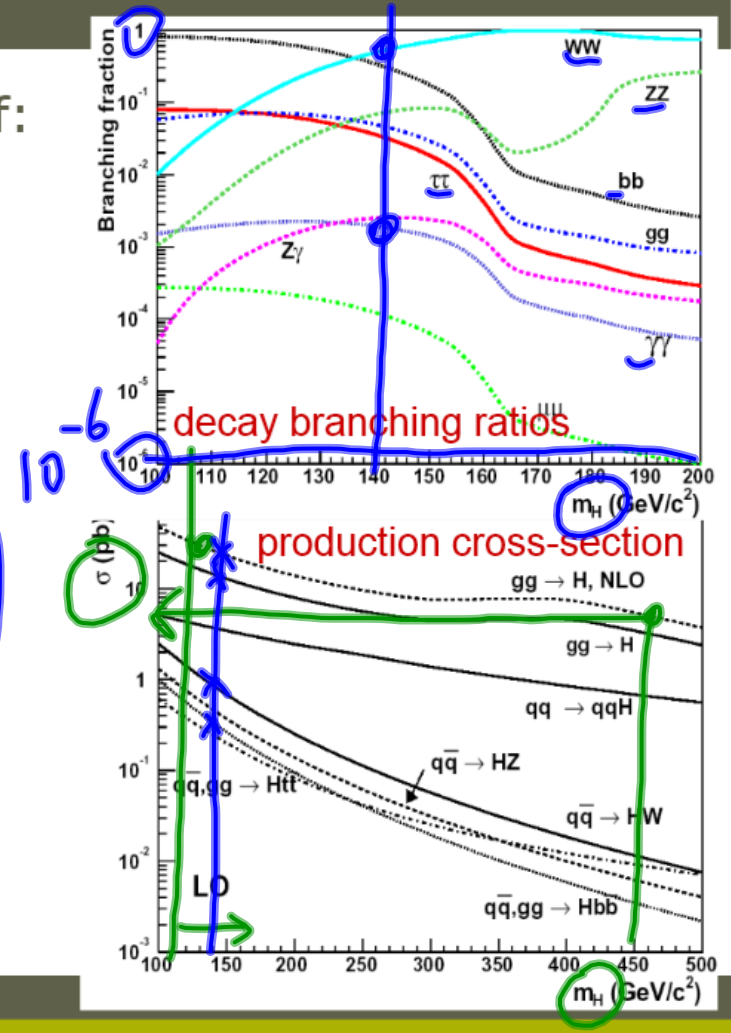

Beam crossings evolution

- Also empty bunch spaces are needed in order to be able to dump the proton beam properly
- Therefore need ~3600 bunch spaces (= 25 ns)
- 25 ns = 27 km / (c . 3600)

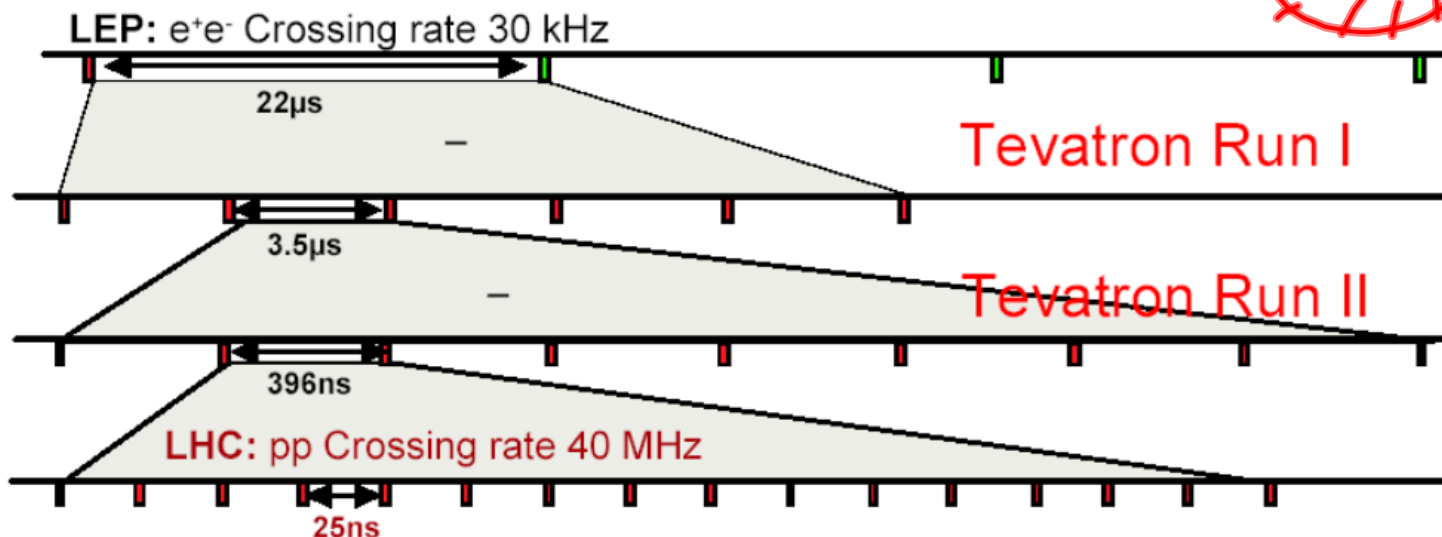
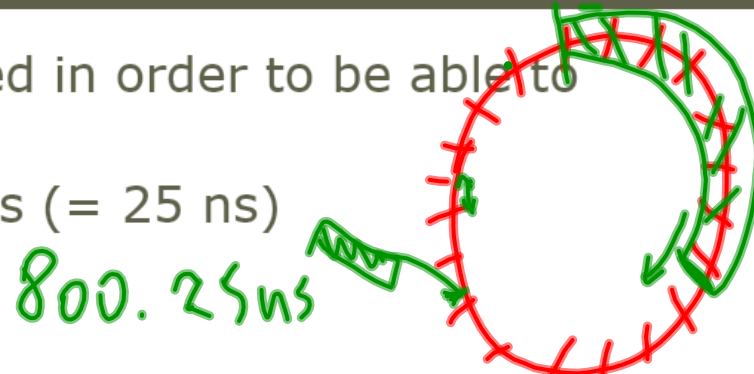

The Large Hadron Collider (LHC)

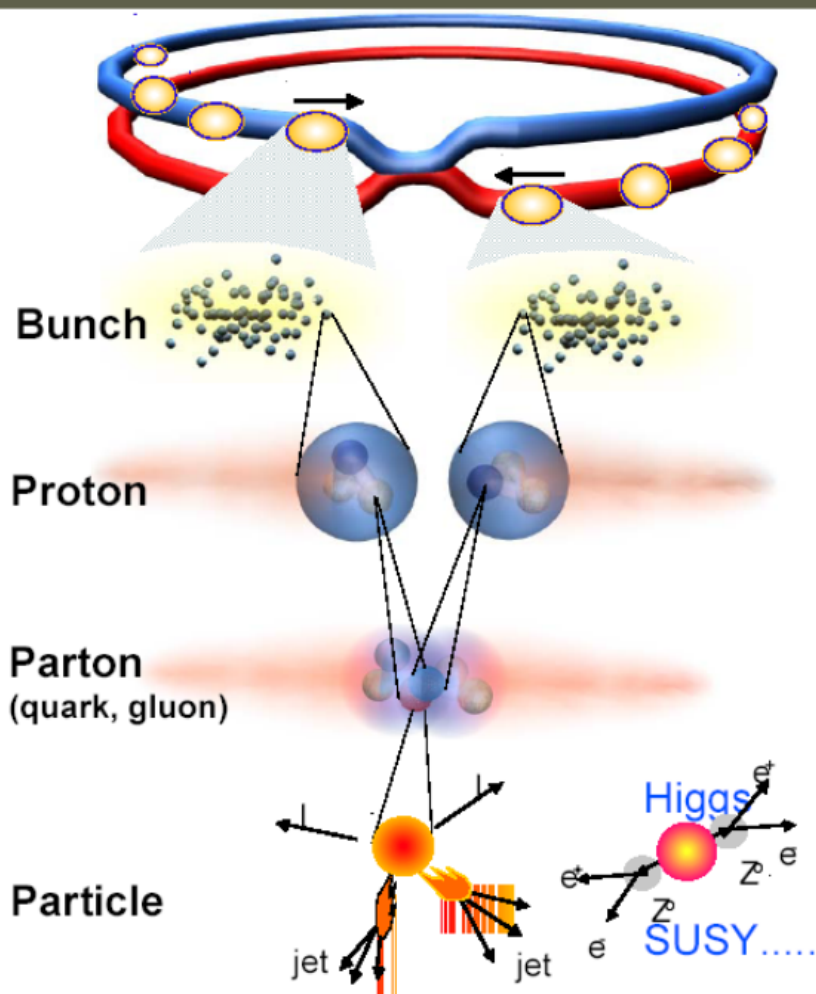

Proton - Proton	2804 bunch/beam
Protons/bunch	10^{11}
Beam energy	7 TeV (7×10^{12} eV)
Luminosity	$10^{34} \text{cm}^{-2} \text{s}^{-1}$

Collision rate 40 MHz

Collision rate \approx $10^7 - 10^9$

New physics rate \approx .00001 Hz

Event selection:
1 in 10,000,000,000,000

Cross section and minimum bias: in-time pile-up

- How many interactions per beam crossing ?

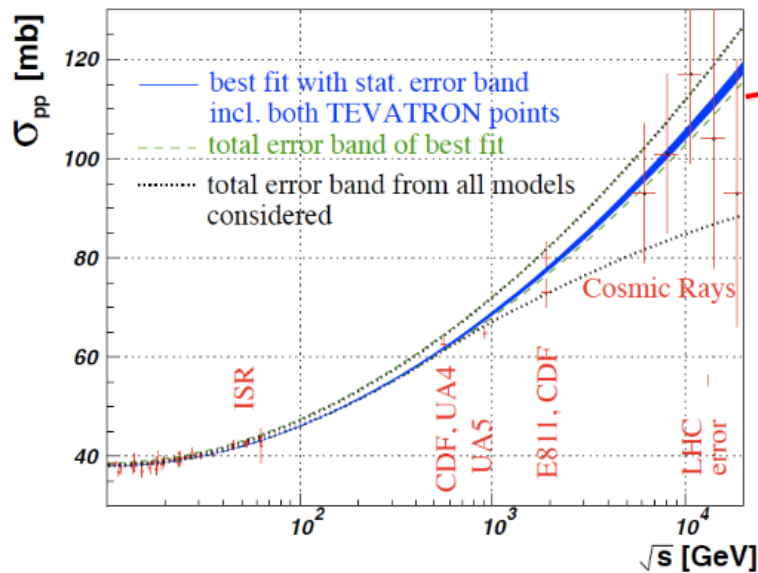

- Therefore a Higgs boson process $(pp \rightarrow HX)$ comes together with ~ 36 minimum bias events

- $Luminosity = 10^{34} \text{ cm}^{-2} \text{ s}^{-1}$
 $= 10^7 \text{ mb}^{-1} \text{ Hz}$

- $\sigma(pp) \sim 115 \text{ mb}$

- $\Rightarrow rate = R * \sigma = 1.15 \cdot 10^9 \text{ Hz}$

- time for one beam crossing
 $\Delta t = 25 \text{ ns} = 2.5 \cdot 10^{-8} \text{ s}$

- $\Rightarrow interaction/crossing = rate \cdot \Delta t$
 $= 28,75$

- not all bunches are full
 (only 2835 out of 3564)

- $\Rightarrow interactions / \text{"active" crossing}$
 $= 28,75 \left(\frac{2835}{3564} \right)^{-1} = \underline{\underline{36}}$

Time-of-flight of signal: out-of-time pile-up

$c=30\text{cm/ns}$; in 25ns, s=7.5m

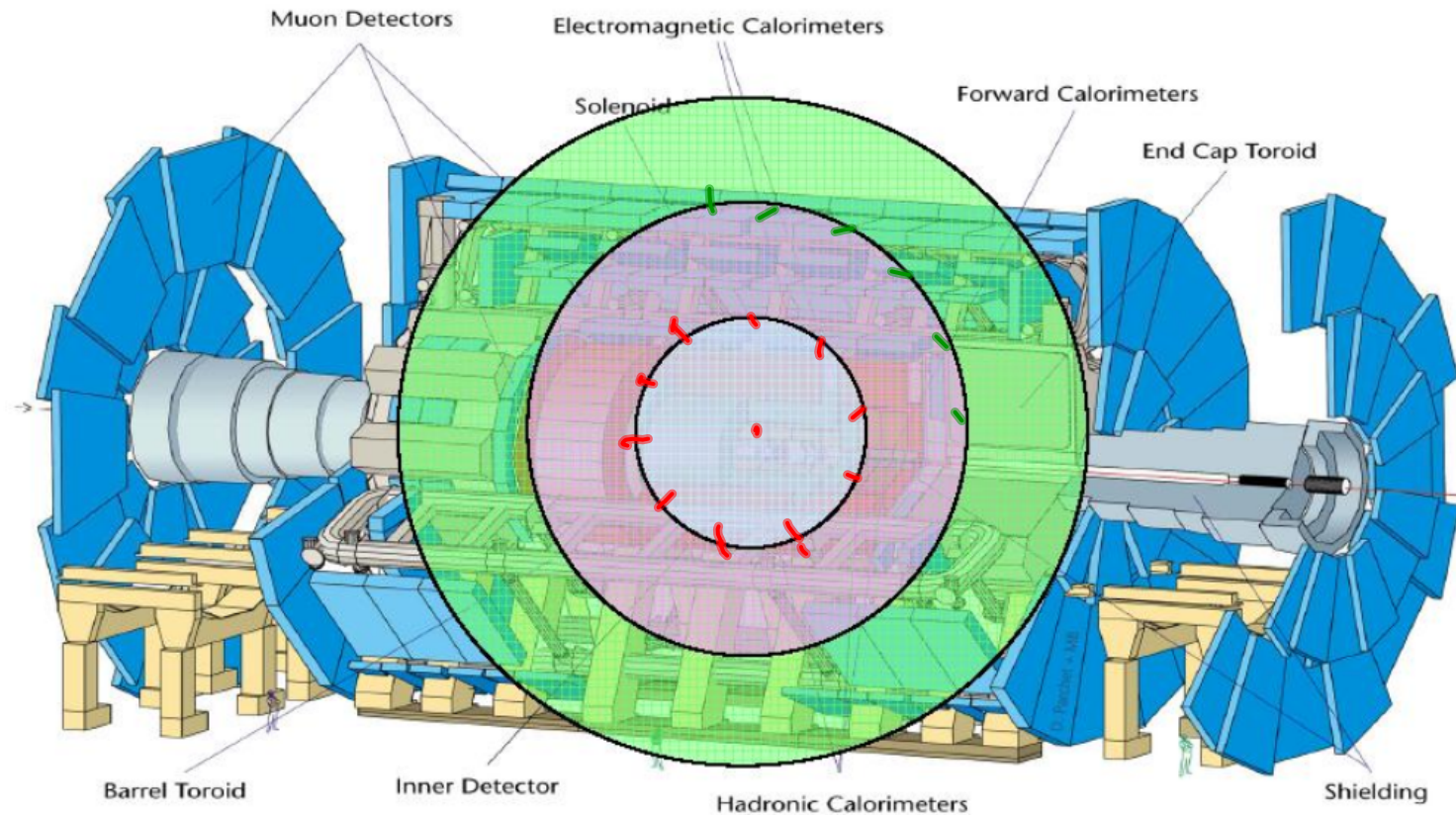

Superimposed pile-up collisions

■ “In-time” pile-up: particles from the same crossing but from a different pp interaction

■ Long detector response/pulse shapes:

- ◆ “Out-of-time” pile-up: left-over signals from interactions in previous crossings
- ◆ Need “bunch-crossing identification”

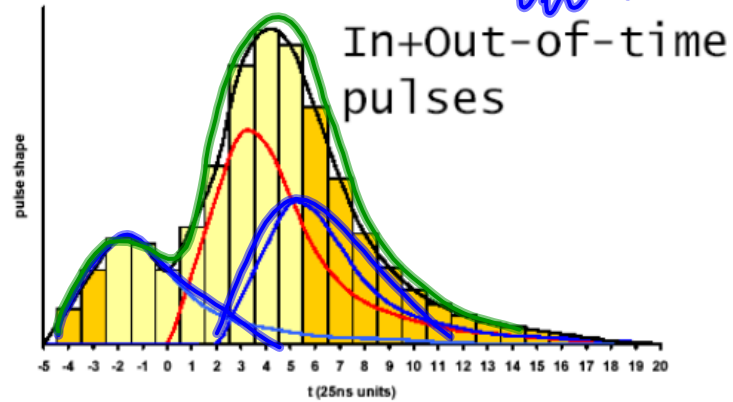
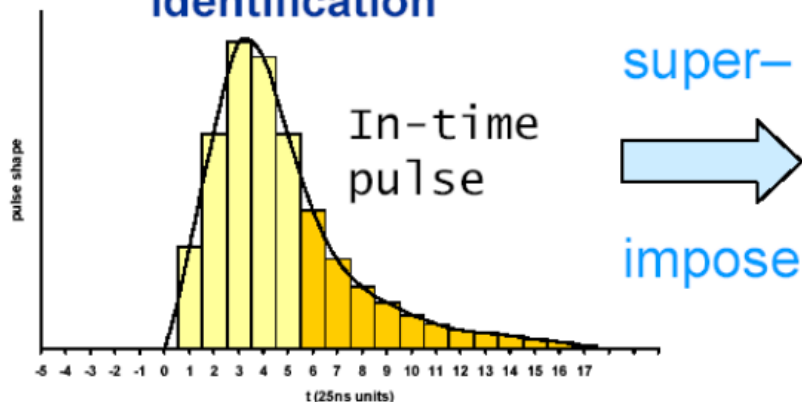
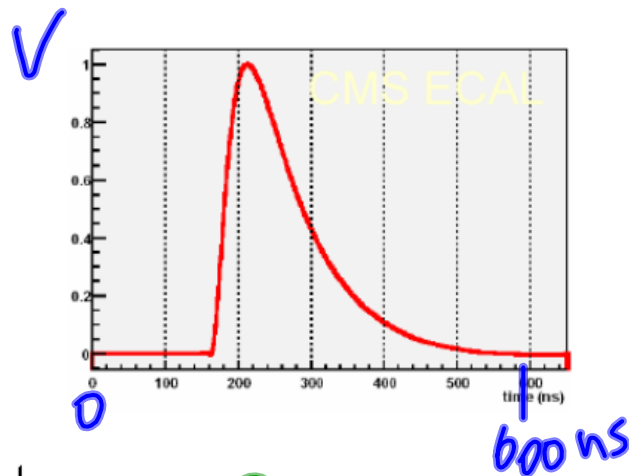

Impact on detector design

- **LHC detectors must have fast response**
 - ◆ Avoid integrating over many bunch crossings (“pile-up”)
 - ◆ Typical response time : 20-50 ns
 - integrate over 1-2 bunch crossings → pile-up of 25-50 min-bias events → very challenging readout electronics
- **LHC detectors must be highly granular**
 - ◆ Minimize probability that pile-up particles be in the same detector element as interesting object (e.g. γ from $H \rightarrow \gamma\gamma$ decays)
 - large number of electronic channels
- **LHC detectors must be radiation resistant:**
 - ◆ high flux of particles from pp collisions → high radiation environment e.g. in forward calorimeters:
 - up to 10^{17} n/cm² in 10 years of LHC operation
 - up to 10^7 Gy (1 Gy = unit of absorbed energy = 1 Joule/Kg)

FAUZE

- INLEIDING HEP
- PARAMETERS EXPERIMENT
(BEPALD DOOR FYSICA)

⇒ DESIGN DETECTOR
& TRIGGER

(40 MHz $\xrightarrow{\text{TRIGGER}}$ 100 Hz)

NU: DESIGN TRIGGER !

The Compact Muon Solenoid

One of the main particle detectors which will collect the outcome of the proton collisions at the LHC is the CMS detector.

A multi-purpose detector with millions of read-out channels and electronics at sampling frequencies of 40MHz similar to the collision rate.

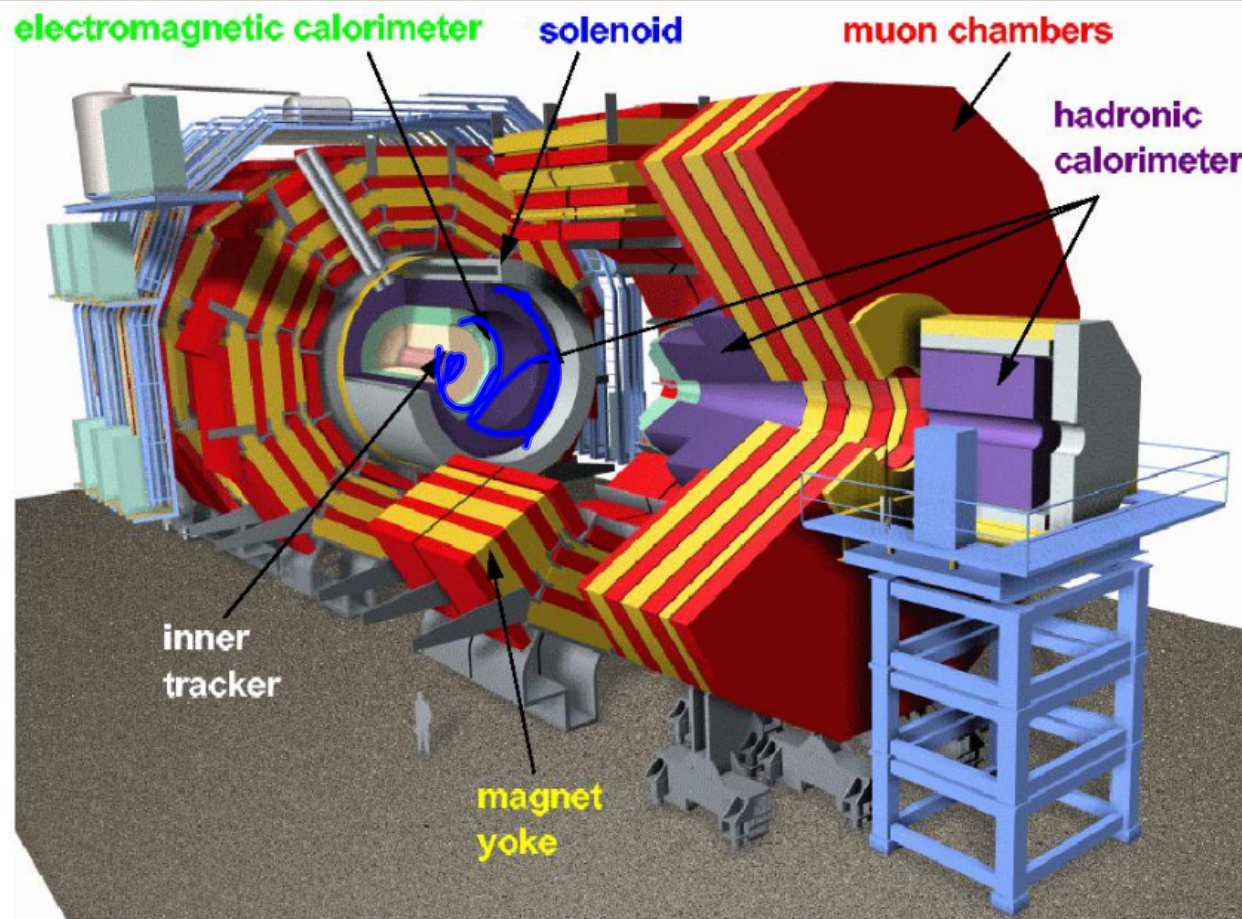

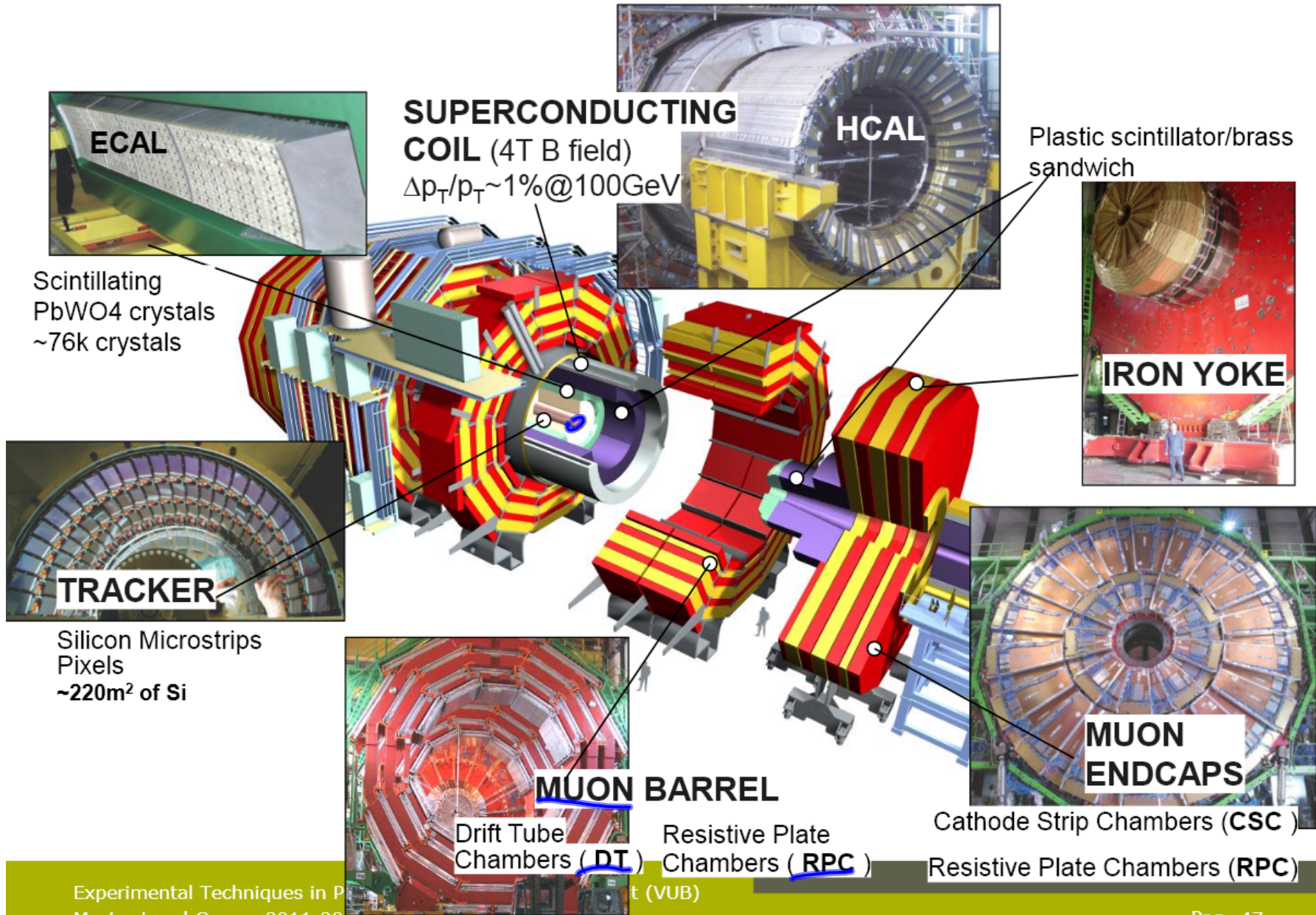

Enormous amount of data sources

sub-detector	number of channels	number of FE chips	number of detector data links	number of data sources (FEDs)	number of DAQ links (FRLs)
Tracker pixel	≈ 66 M	15840	≈ 1500	40	40
Tracker strips	≈ 9.3 M	≈ 72 k	≈ 36 k	440	250 (merged)
Preshower	144384	4512	1128	56	56
ECAL	75848	≈ 21 k	≈ 9 k	54	54
HCAL	9072	9072	3072	32	32
Muons CSC	≈ 500 k	≈ 76 k	540	8	8
Muons RPC	192 k	≈ 8.6 k	732	3	3
Muons DT	195 k	48820	60	10	10
Global Trigger	n/a	n/a	n/a	3	3
CSC, DT Track Finder	n/a	n/a	n/a	2	2
Total	≈ 77 M			626	458

Each data source will deliver on average ~2kByte per pp collision.

Example of a final state event

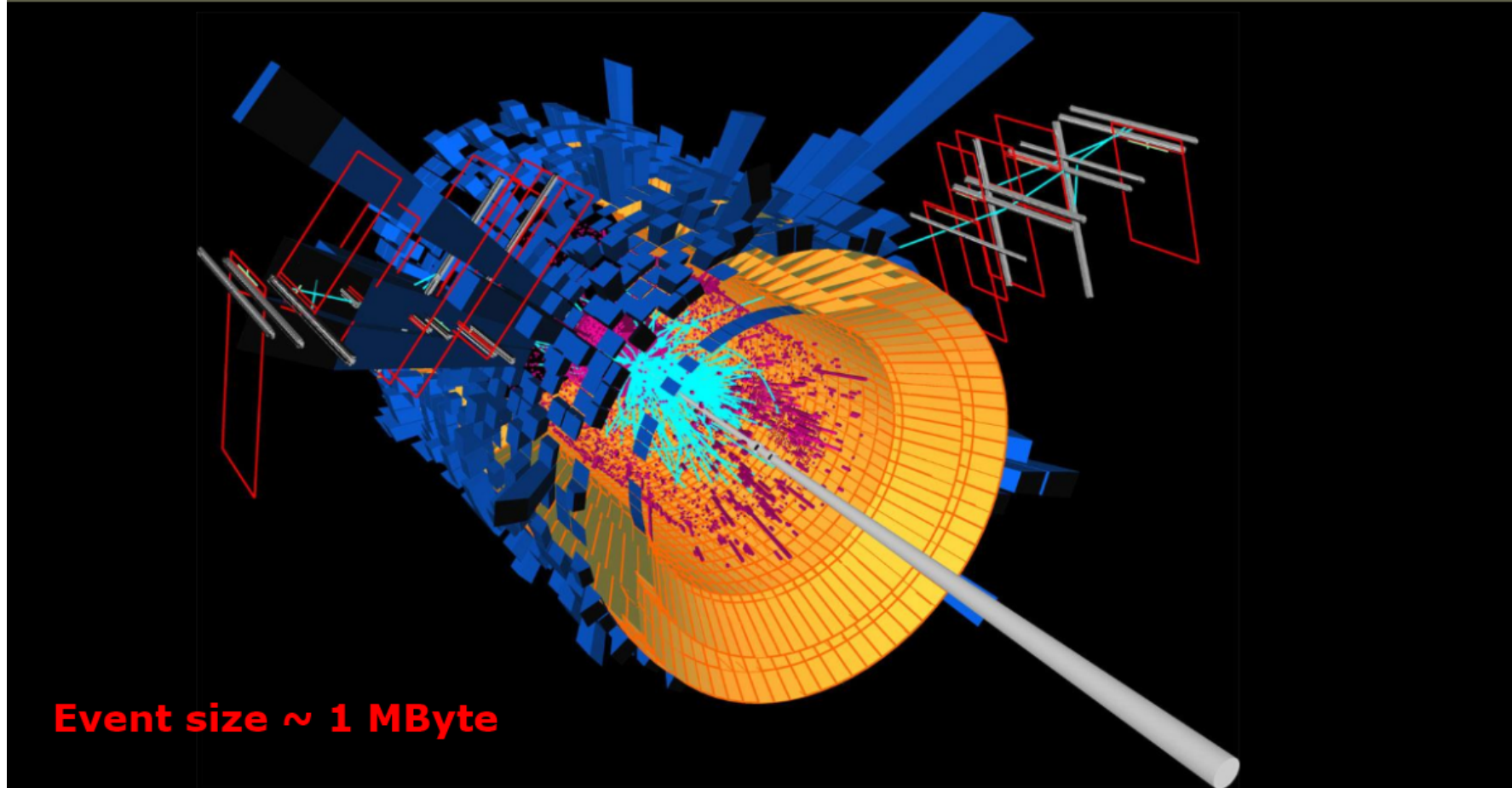

Event size ~ 1 MByte

Selectivity of the physics signals

- **Cross sections of physics processes vary over many orders of magnitude**

- ◆ Inelastic: 10^9 Hz
- ◆ $W \rightarrow \ell \nu$: 10^2 Hz
- ◆ $t \bar{t}$ production: 10 Hz
- ◆ Higgs ($100 \text{ GeV}/c^2$): 0.1 Hz
- ◆ Higgs ($600 \text{ GeV}/c^2$): 10^{-2} Hz

- **QCD background**

- ◆ Jet $E_T \sim 250 \text{ GeV}$: rate = 1 kHz
- ◆ Jet fluctuations \rightarrow electron bkg
- ◆ Decays of $K, \pi, b \rightarrow$ muon bkg

- **Selection needed: $1:10^{10-11}$**

- ◆ Before branching fractions...

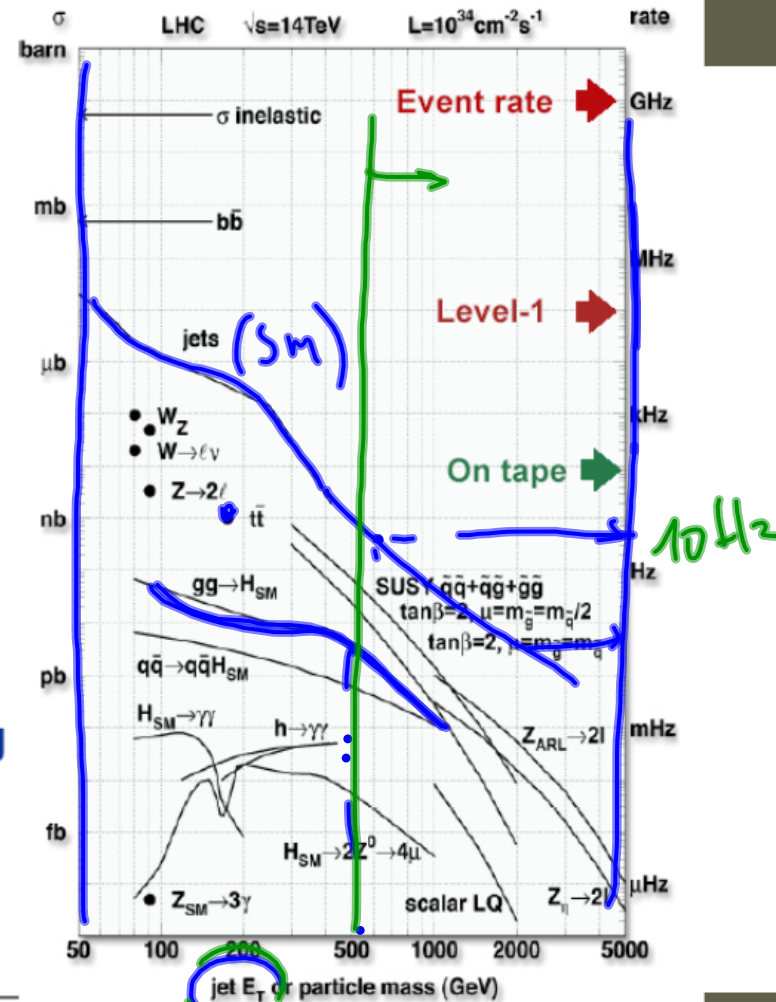

Physics selection at the LHC

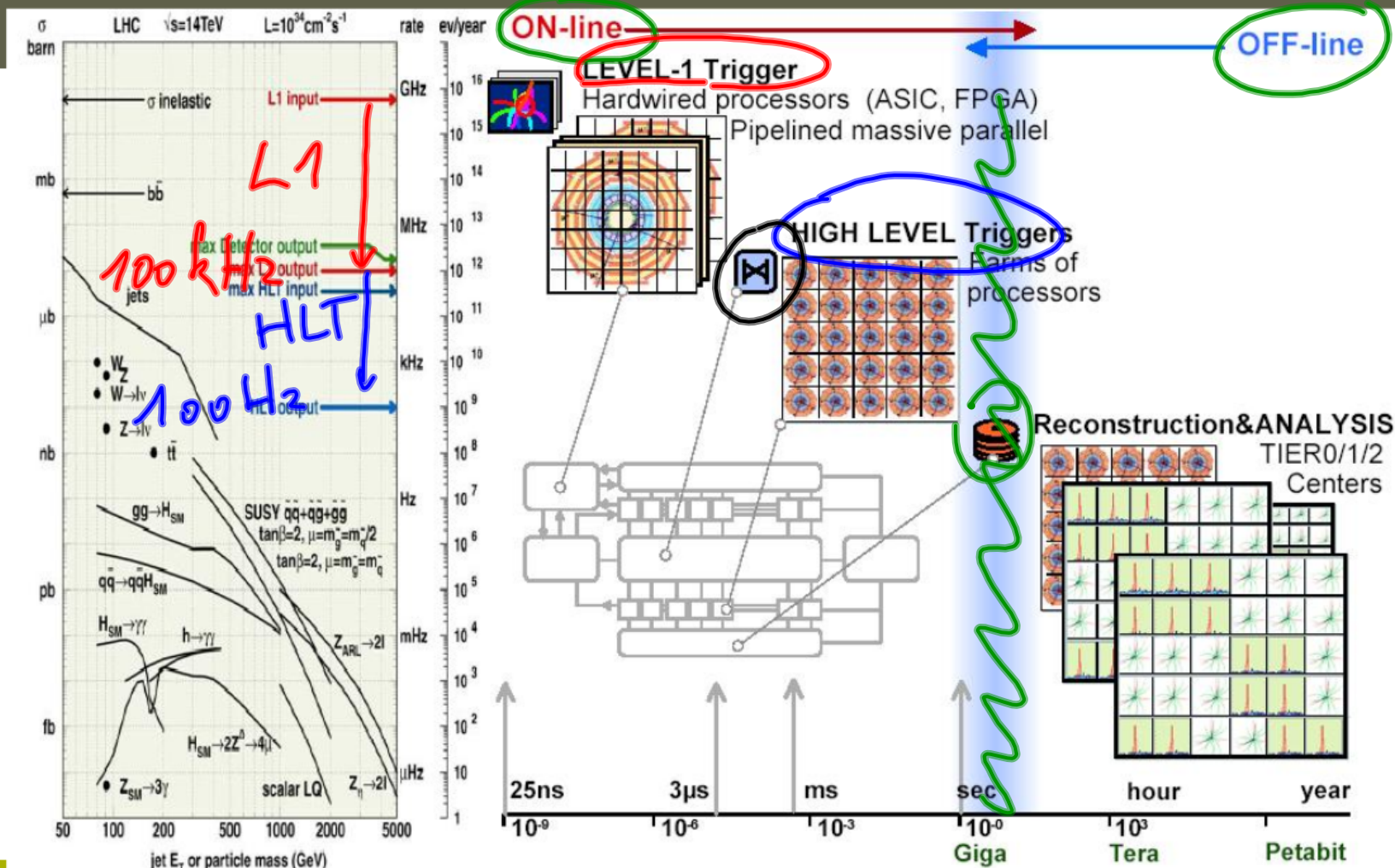

Physics selection at the LHC

40 MHz

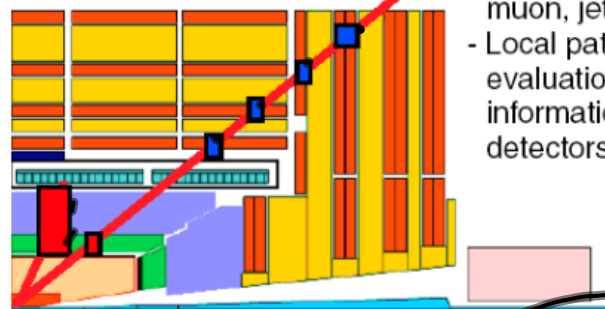

Level-1. Specialized processors

- Particle identification: high p_T electron, muon, jets, missing E_T
- Local pattern recognition and energy evaluation on prompt macro-granular information from calorimeter and muon detectors

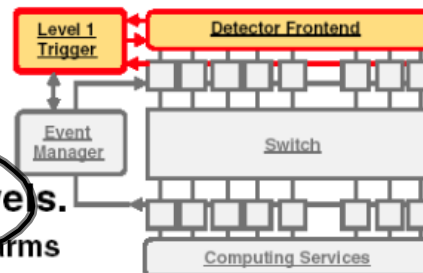

High trigger levels.

Network and CPU farms

- Clean particle signature
- Finer granularity precise measurement
- Kinematics. effective mass cuts & event topology
- Track reconstruction and detector matching
- Event reconstruction and analysis

Up to 100 kHz

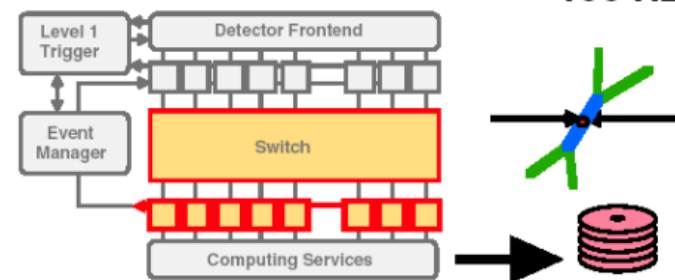
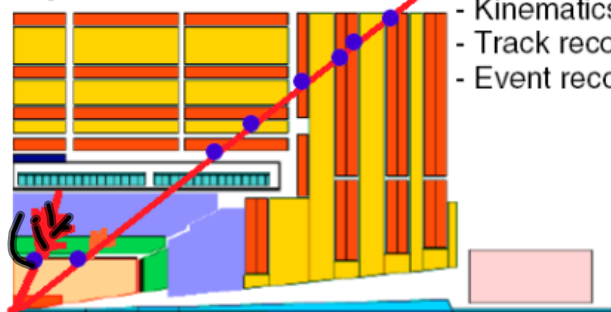

≈ 100 Hz

Reference for Level-1 in CMS

Public manuscript written in 2000 and contains lots of information on the Level-1 Trigger of the CMS experiment. Almost 600 pages. Can be found at http://cms.cern.ch/iCMS/jsp/page.jsp?mode=cms&action=url&urlkey=CMS_TDRS

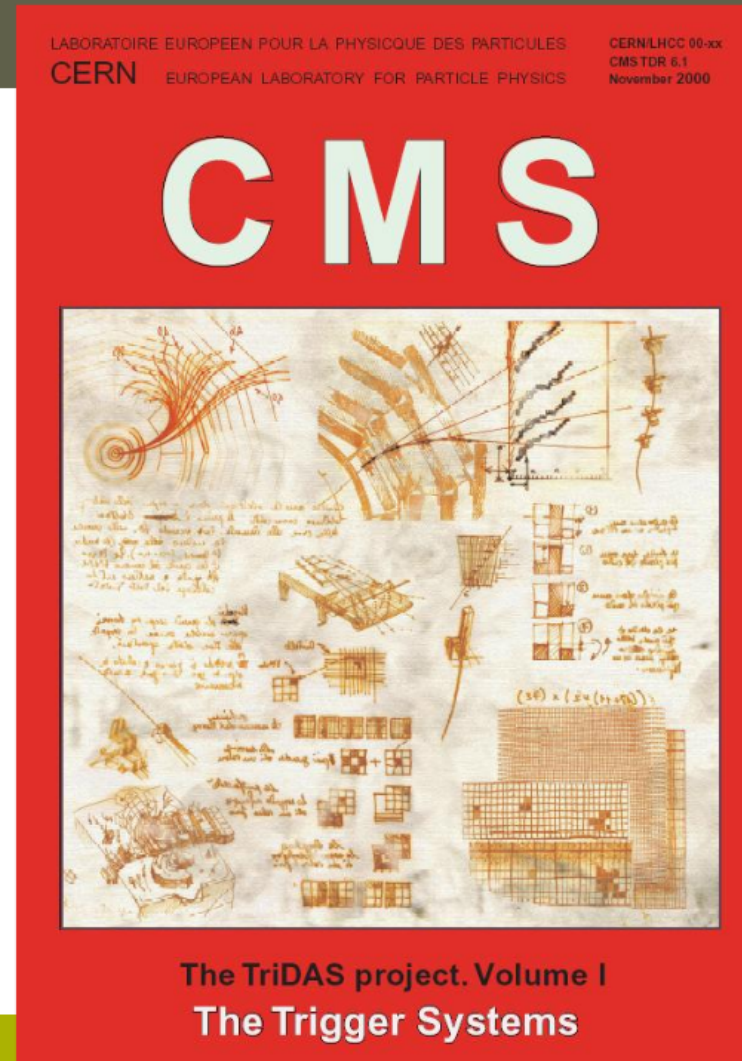

Reference for HLT in CMS

Public manuscript written in 2002 and contains lots of information on the High Level Trigger of the CMS experiment. Almost 500 pages. Can be found at http://cms.cern.ch/iCMS/jsp/page.jsp?mode=cms&action=url&urlkey=CMS_TDRS

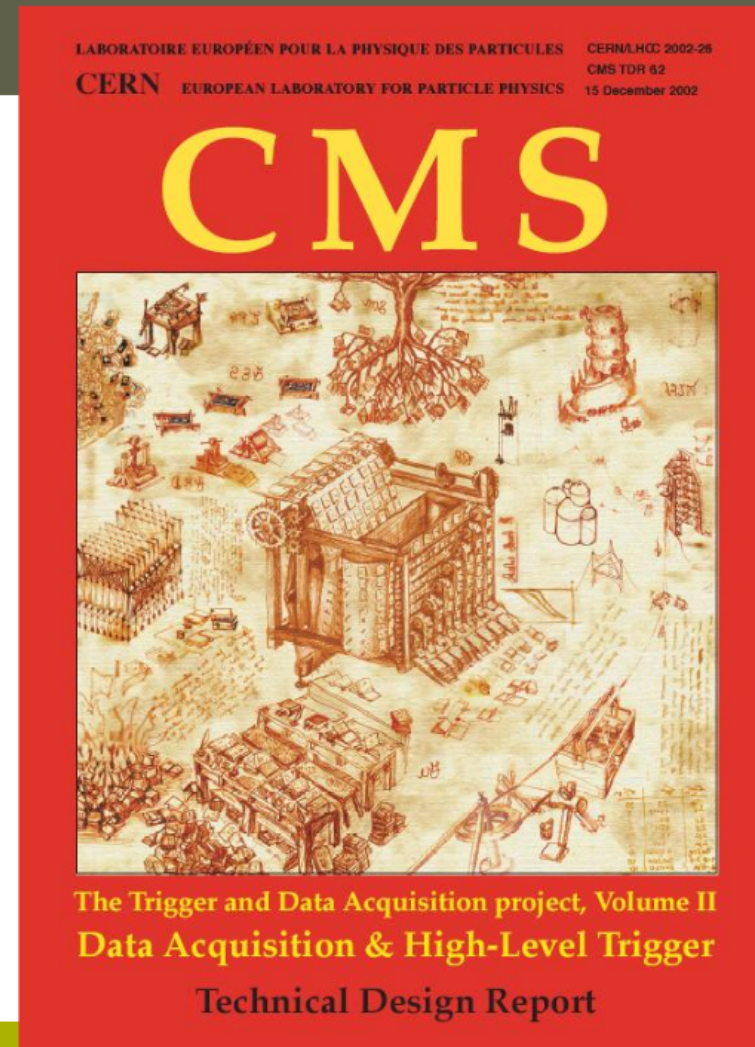

Trigger structures

First L1 reduction from 40MHz to 10^5Hz (cfr 10^2Hz final rate to tape/disk) is always there, followed by 1 or 2 extra steps.

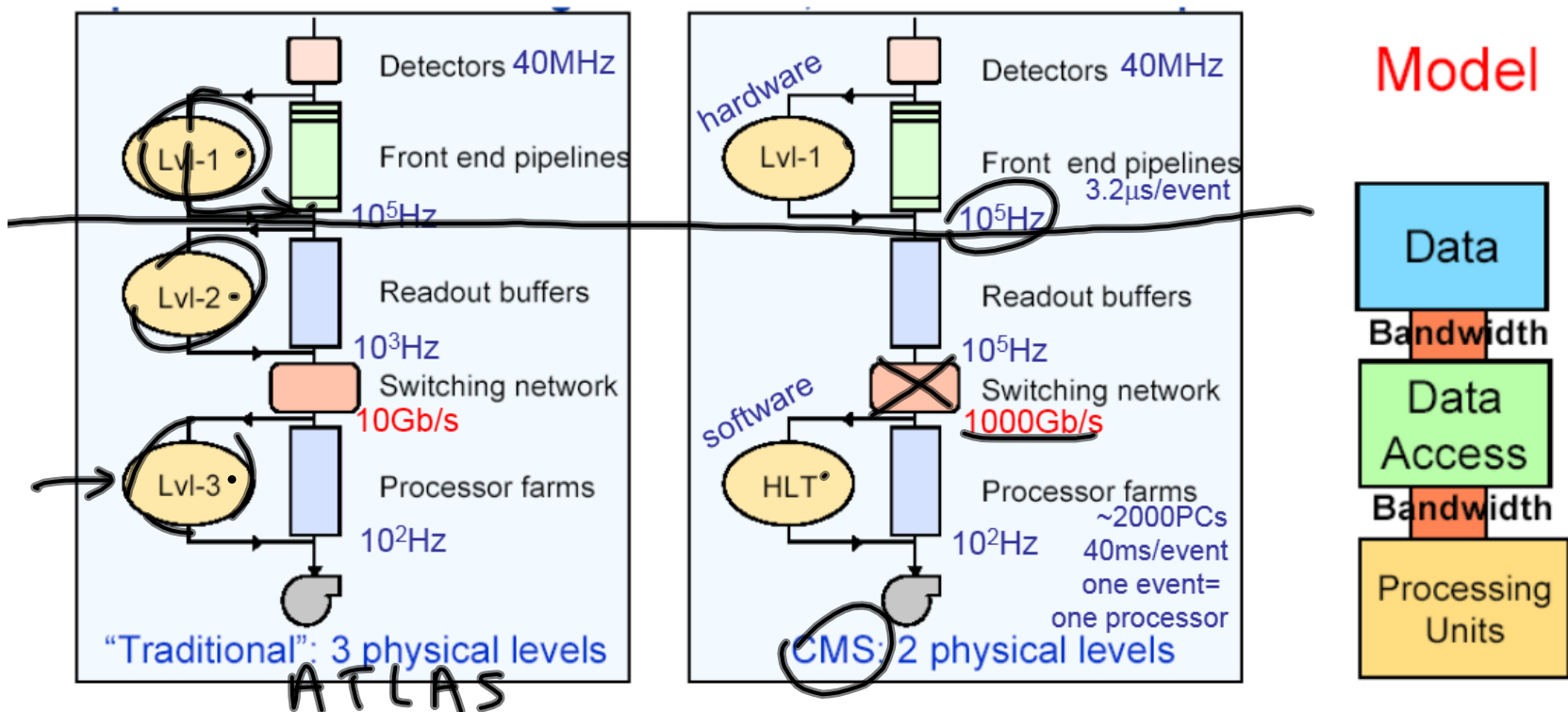

Trigger structures

3-step approach

- Control logistics
- Specialized processors

2-step approach

- Bandwidth important
- Commercial processors

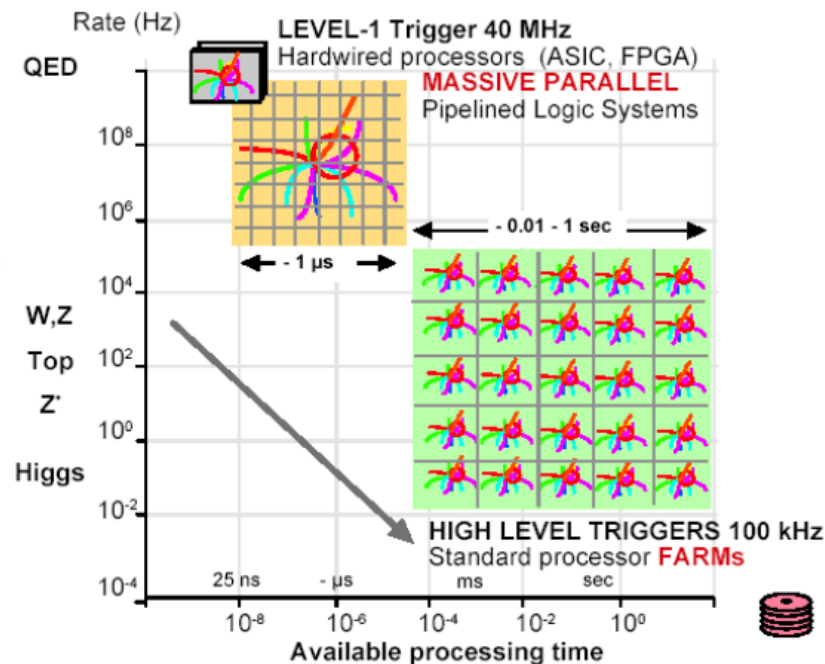
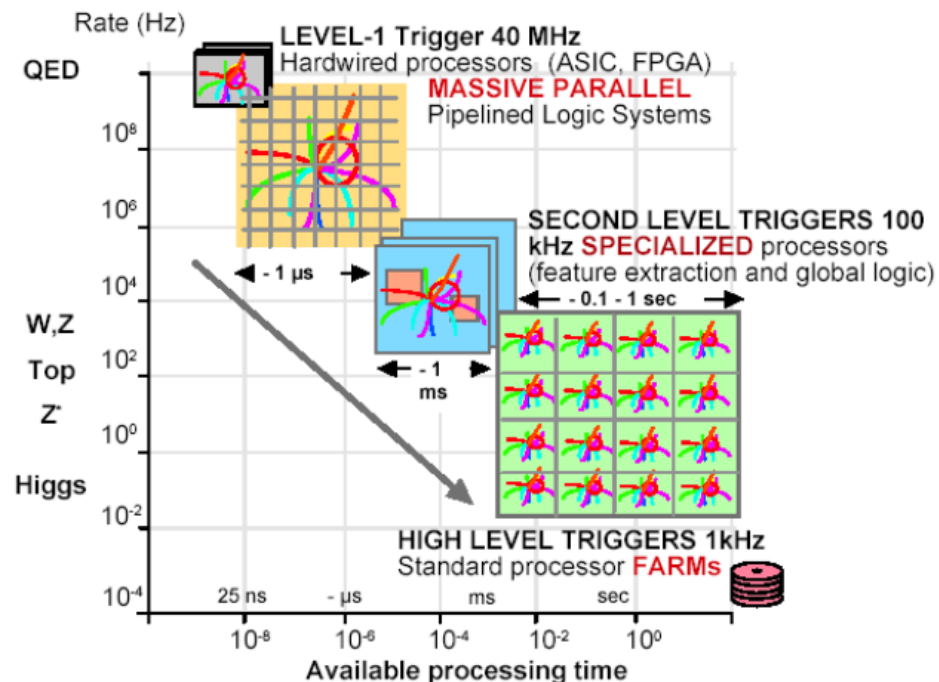

Data flow in the CMS experiment

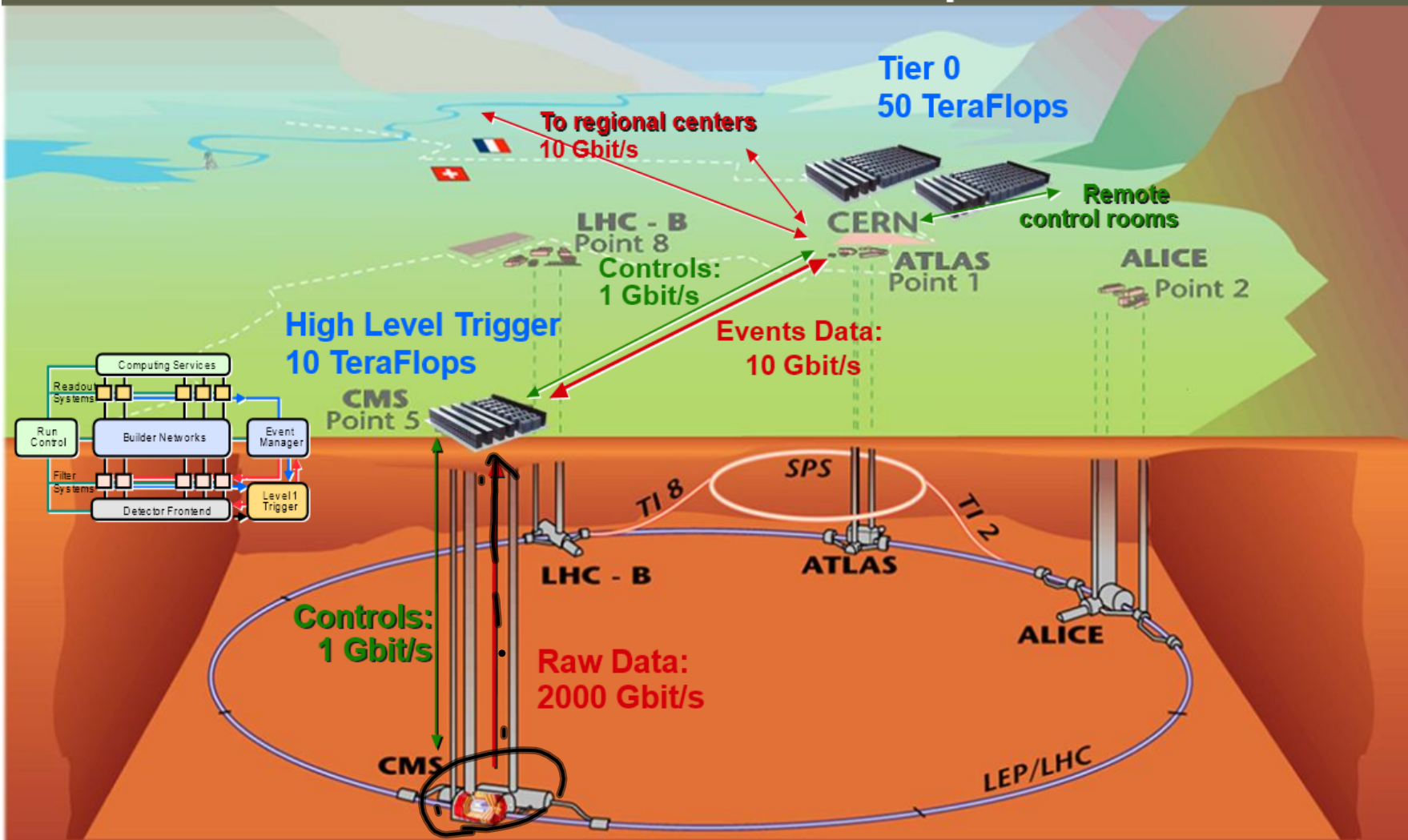

The Level-1 trigger

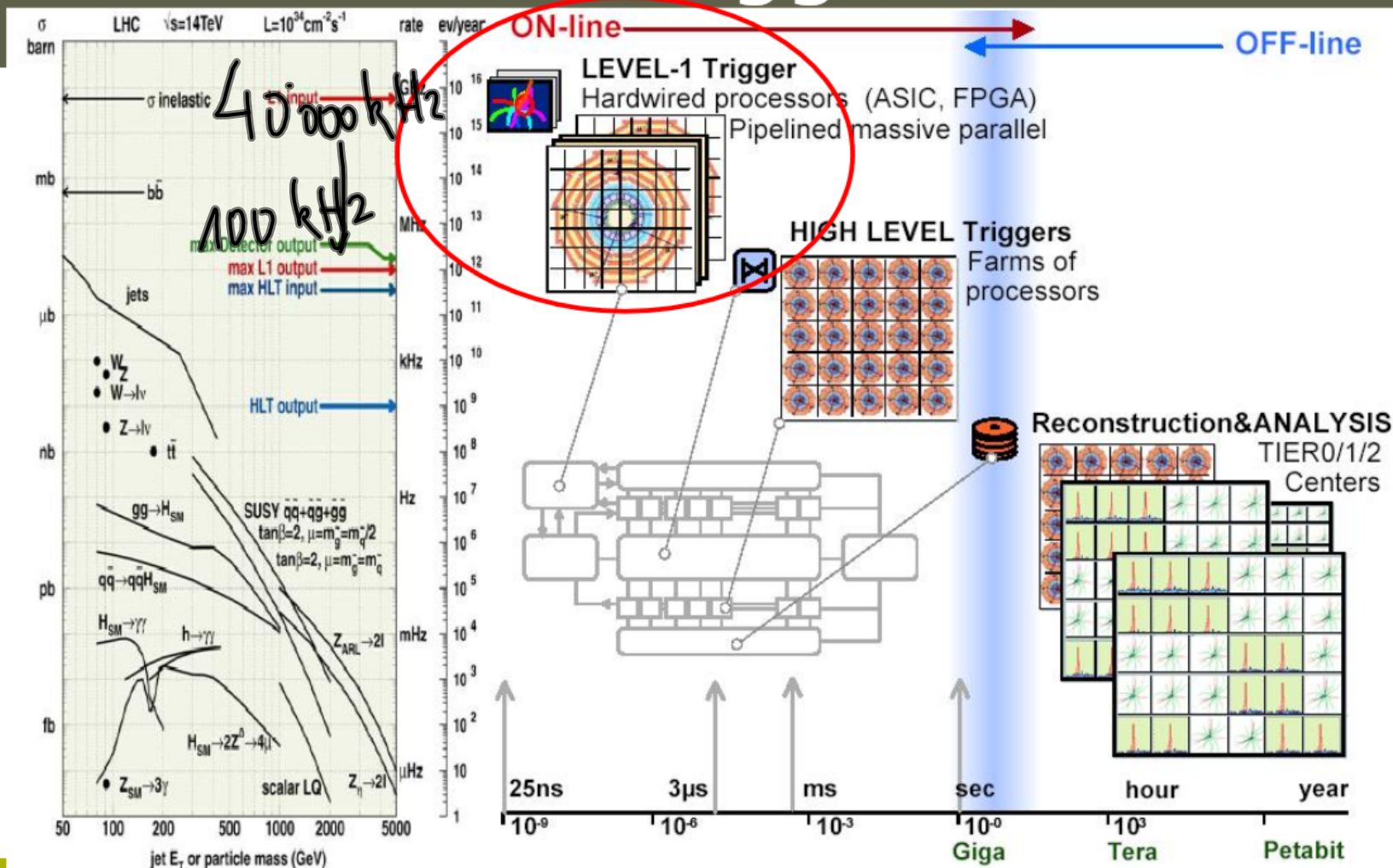

The Level-1 trigger

- The Level-1 trigger algorithms have to analyze every bunch crossing
- To get a quasi-deadtime-free operation, pipelines (or electronic buffers) are installed at the detectors to cover the $3.2 \mu\text{s}$ time needed for the trigger decision
- The decision is based on algorithms which are calculated by specific processors (=hardware)

Level-1 trigger algorithms

- **Physics facts:**
 - ◆ pp collisions produce mainly hadrons with $P_T \sim 1$ GeV
 - ◆ Interesting physics (old and new) has particles (leptons and hadrons) with large transverse momenta:
 - $W \rightarrow e\nu$: $M(W) = 80 \text{ GeV}/c^2$; $P_T(e) \sim 30\text{-}40 \text{ GeV}$
 - $H(120 \text{ GeV}) \rightarrow \gamma\gamma$: $P_T(\gamma) \sim 50\text{-}60 \text{ GeV}$
- **Basic requirements:**
 - ◆ Impose high thresholds on particles
 - Implies distinguishing particle types; possible for electrons, muons and “jets”; beyond that, need complex algorithms
 - ◆ Typical thresholds:
 - Single muon with $P_T > 20 \text{ GeV}$ (rate $\sim 10 \text{ kHz}$)
 - Dimuons with $P_T > 6$ (rate $\sim 1 \text{ kHz}$)
 - Single e/γ with $P_T > 30 \text{ GeV}$ (rate $\sim 10\text{-}20 \text{ kHz}$)
 - Dielectrons with $P_T > 20 \text{ GeV}$ (rate $\sim 5 \text{ kHz}$)
 - Single jet with $P_T > 300 \text{ GeV}$ (rate $\sim 0.2\text{-}0.4 \text{ kHz}$)

Signatures in the detector(s)

Use prompt data (calorimetry and muons) to identify:
High p_t electron, muon, jets,
missing E_T

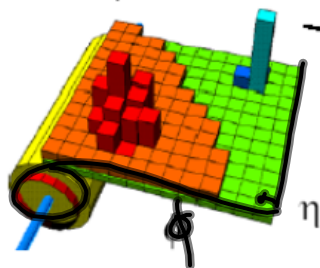

CALORIMETERS

Cluster finding and energy deposition evaluation

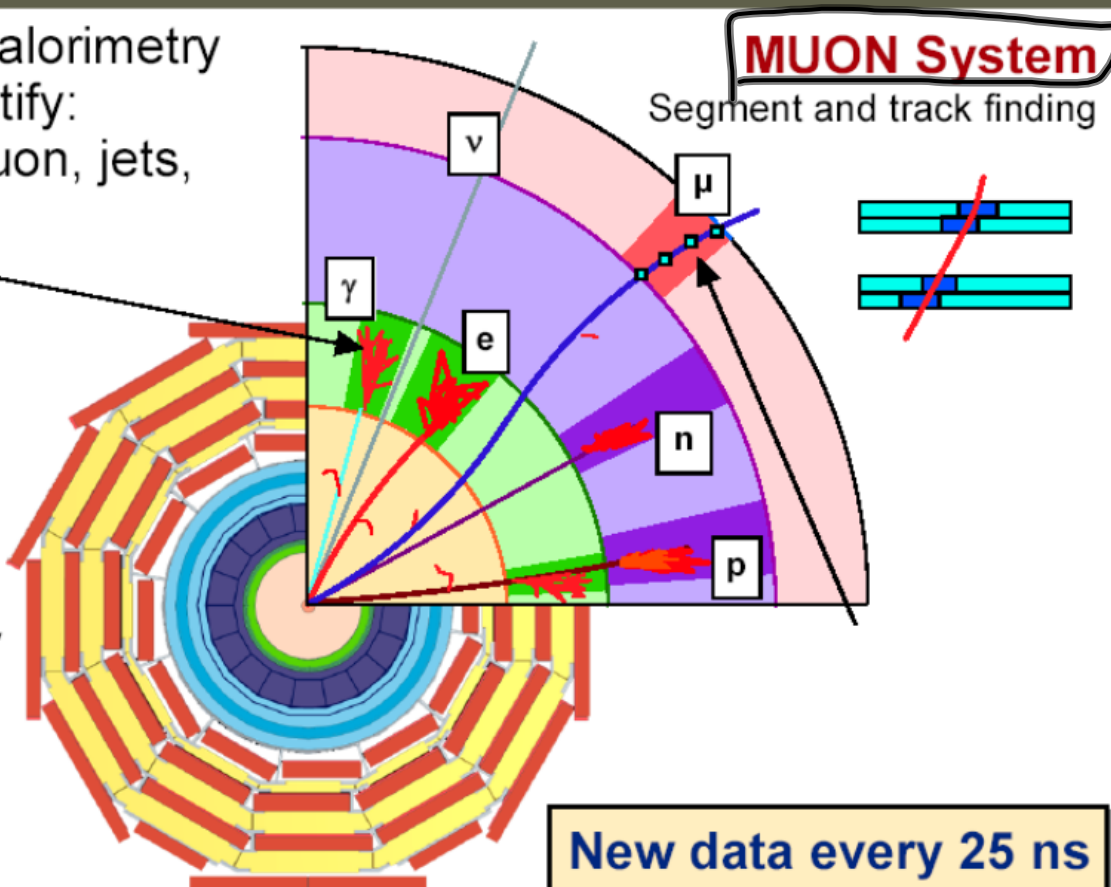

New data every 25 ns
Decision latency ~ μs

Signatures in the detector(s)

- **Pattern recognition much faster/easier**

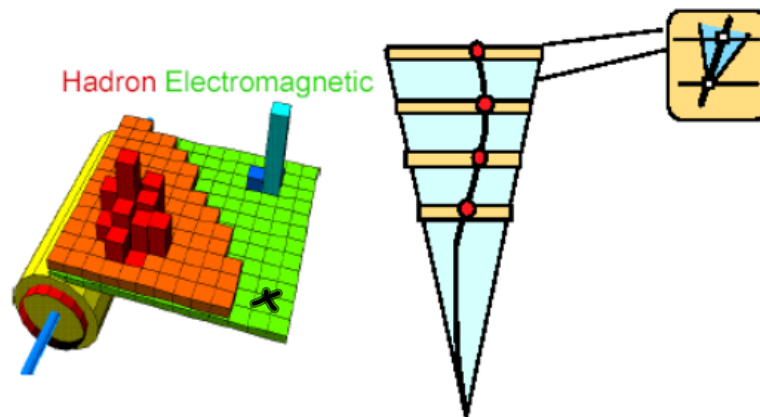

- Simple algorithms
- Small amounts of data
- Local decisions

- **Compare to tracker info**

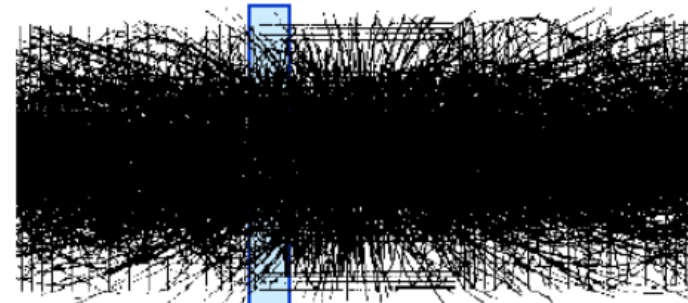

- Complex algorithms
- Huge amounts of data

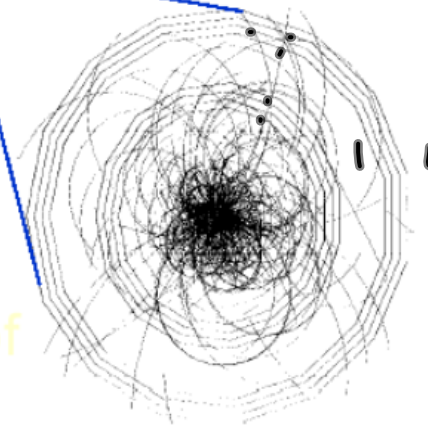

- Need to link sub-detectors

Level-1 trigger decision loop

- **Synchronous 40 MHz digital system**
 - ◆ Typical: 160 MHz internal pipeline
 - ◆ Latencies:
 - Readout + processing: < 1 μ s
 - Signal collection & distribution: \approx 2 μ s
- **At Lvl-1: process only calo+ μ info**

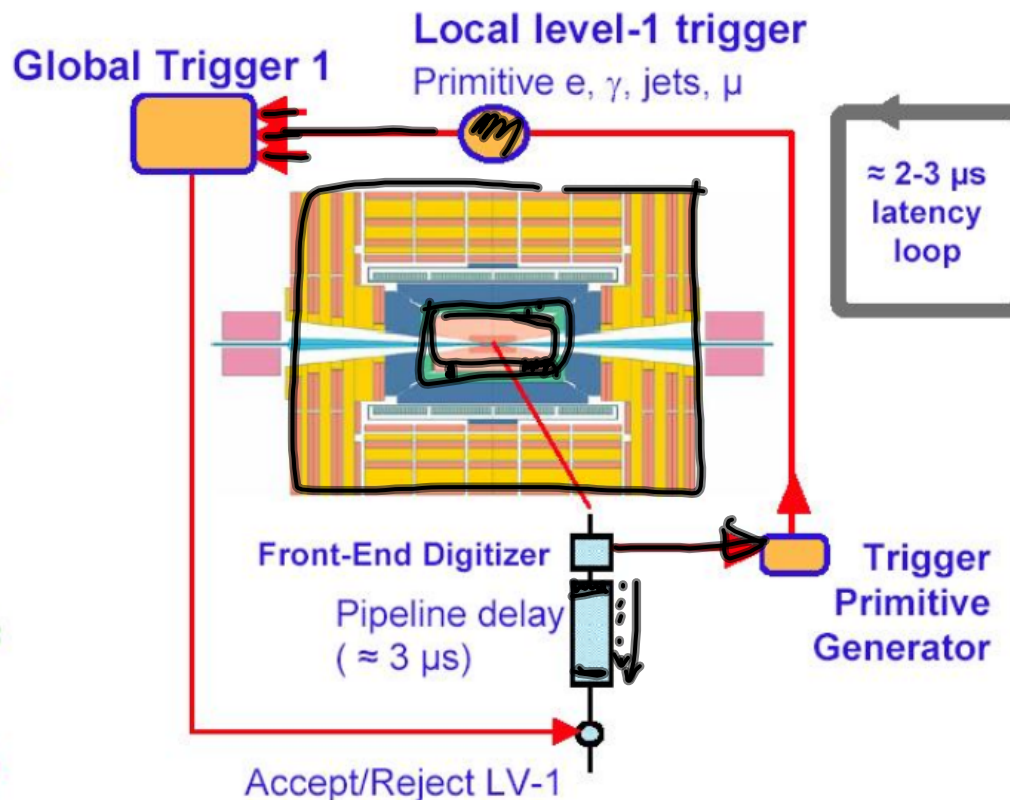

Level-1 is hardware

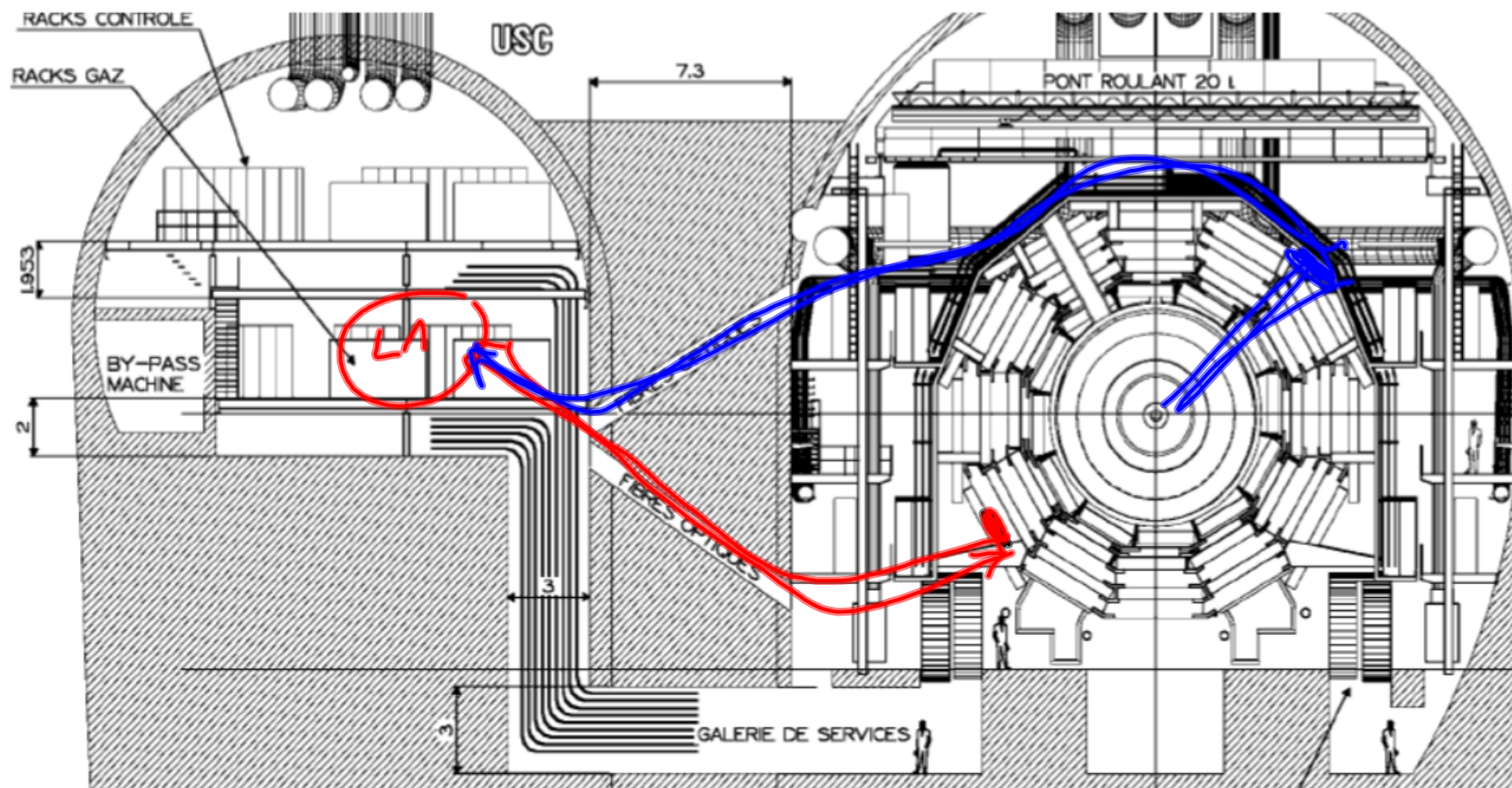

The path of the signal...

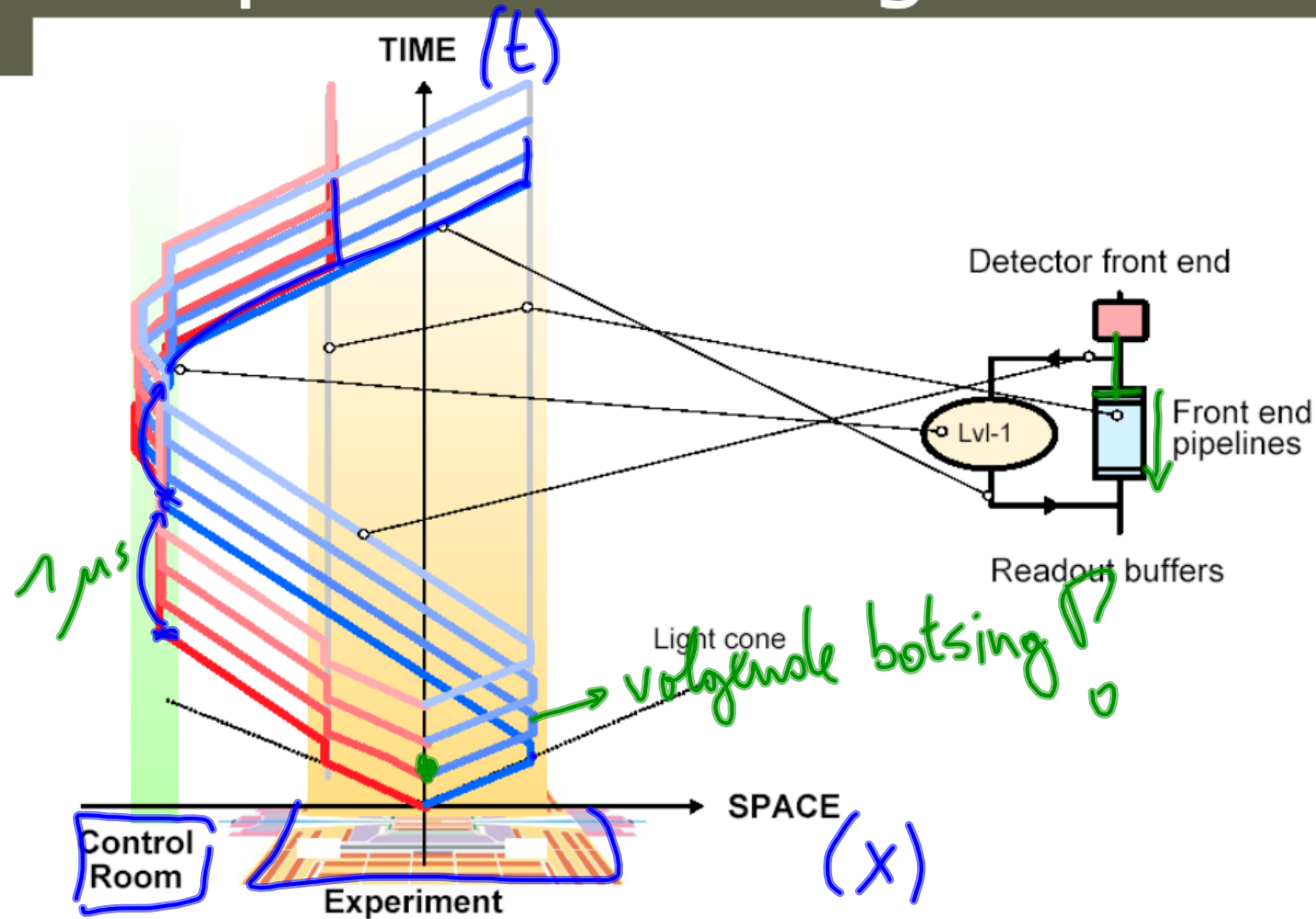

Calorimeter system in CMS

The electro-magnetic calorimeter (ECAL) will help in the reconstruction of electrons and photons. It consists of $\sim 77k$ lead-tungstate crystals equipped with avalanche photodiodes in the barrel or vacuum phototriodes in the endcap.

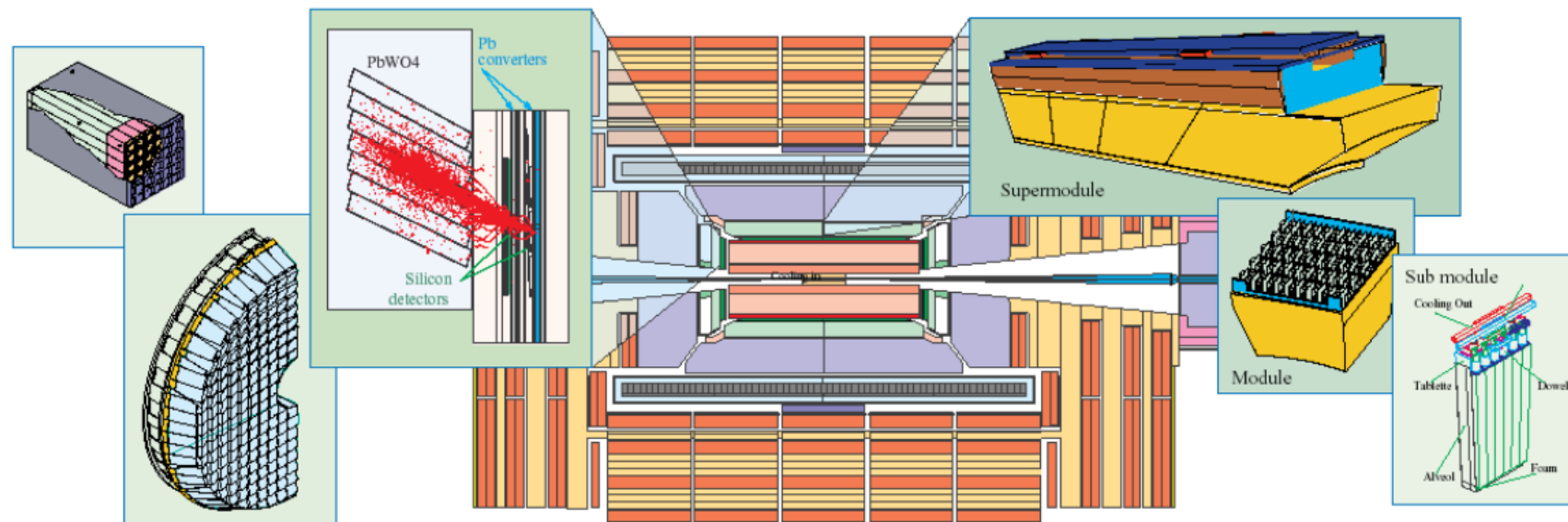

Calorimeter system in CMS

The hadron calorimeter (HCAL) is important for the detection of hadronic jets from quarks, gluons or new particles, and also for the measurement of the missing energy resulting from a neutrino or a new very weakly interacting particle. These are sampling calorimeters of copper absorber plates interleaved with thick scintillator sheets.

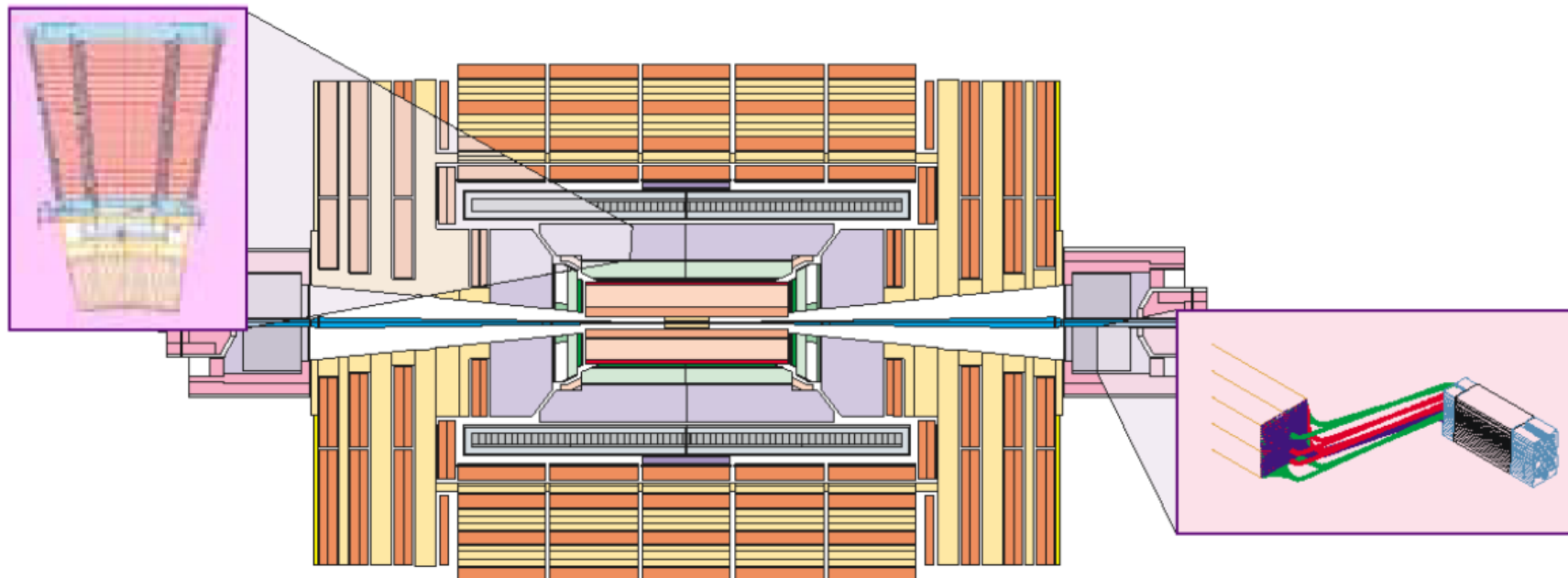

Level-1 Calorimeter trigger

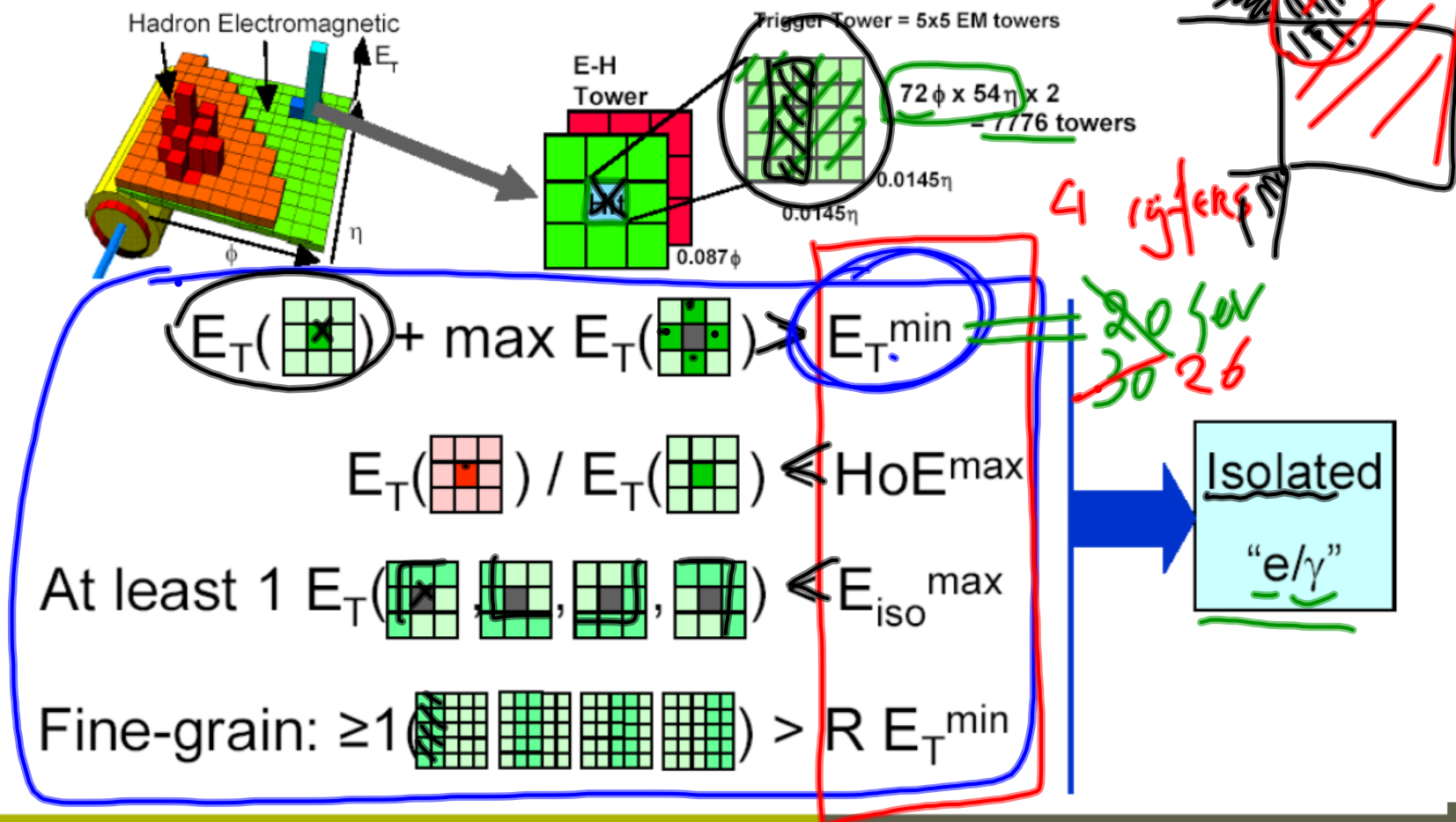

Level-1 Calorimeter trigger

- The efficiency of triggering an event with a reconstructed electron of a given transverse momentum is important (trigger object not necessary the offline object as then we have more time to reconstruct all pieces in the detector).
- To select the signal events (eg. Higgs bosons) among all proton collisions we apply cuts on the transverse momentum of the objects. High mass resonances produce on average objects like electrons with larger transverse momenta.
- But we need to make sure that if we need electrons above $p_T=25\text{GeV}/c$ that we get them on disk after triggering.

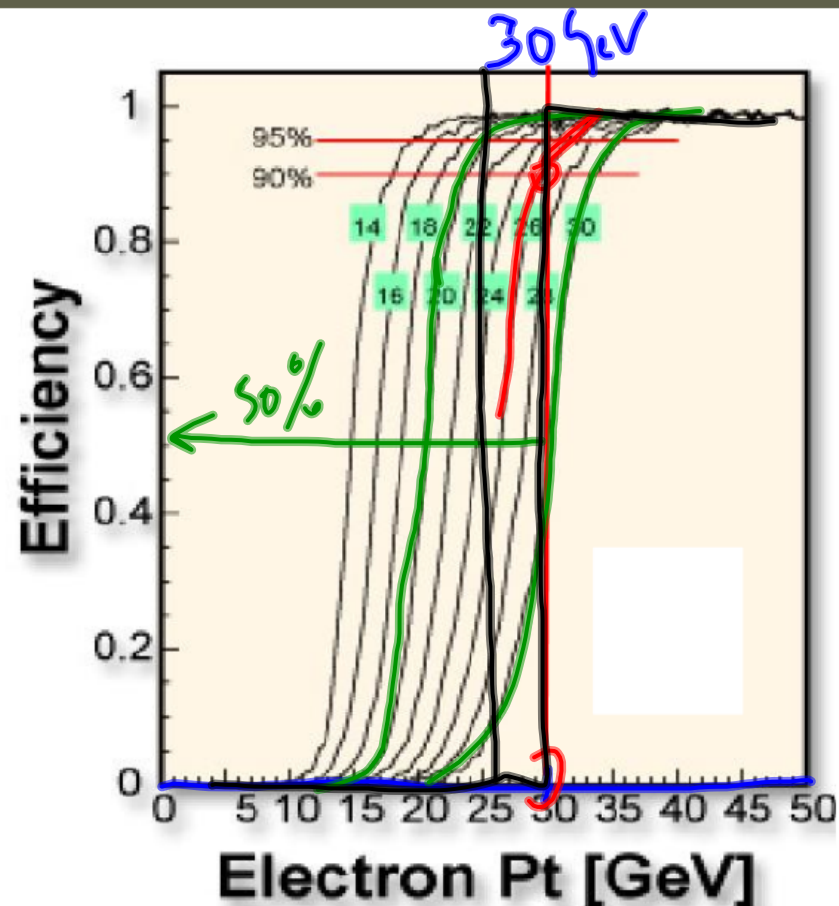

Level-1 Jet and τ trigger

- **Issues are jet energy resolution and tau identification**
 - ◆ Single, double, triple and quad thresholds possible
 - ◆ Possible also to cut on jet multiplicities
 - ◆ Also ETmiss, SET and SET(jets) triggers

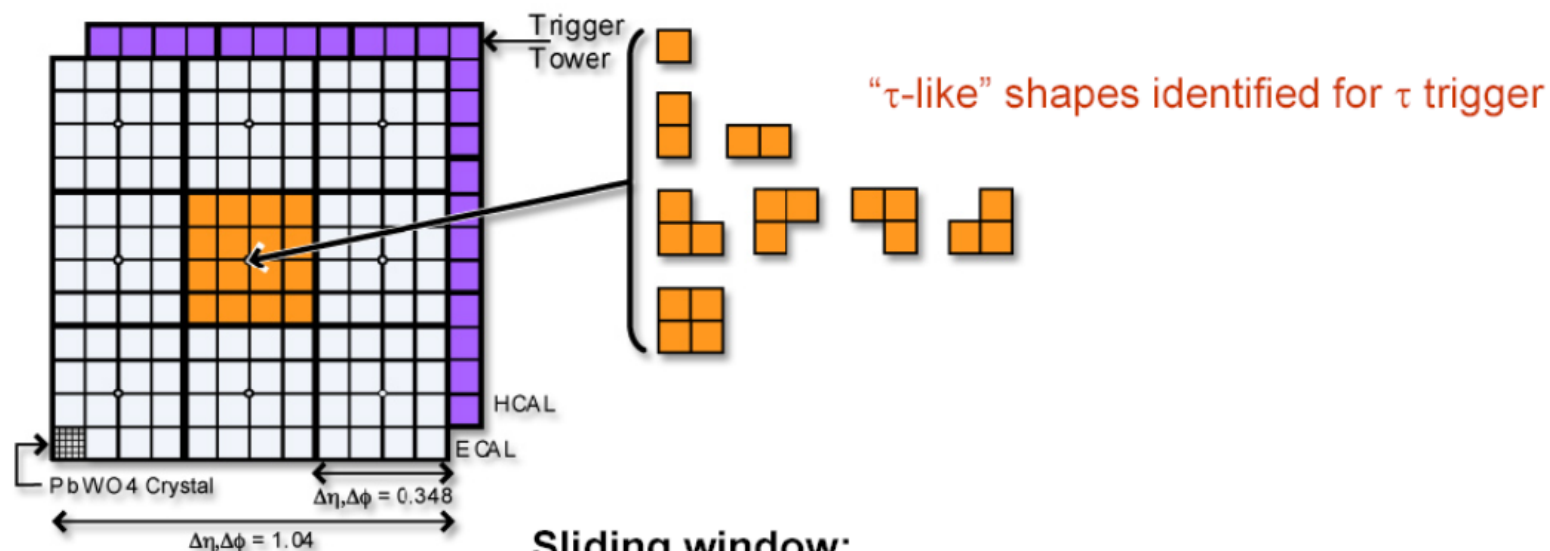

Sliding window:

- granularity is 4x4 towers = trigger region
- jet E_T summed in 3x3 regions $\Delta\eta, \Delta\phi = 1.04$

Level-1 Jet and τ trigger

Similar efficiencies for τ and jets as for electrons. The resolution of these objects is however worse, hence the less sharp turn-on curve.

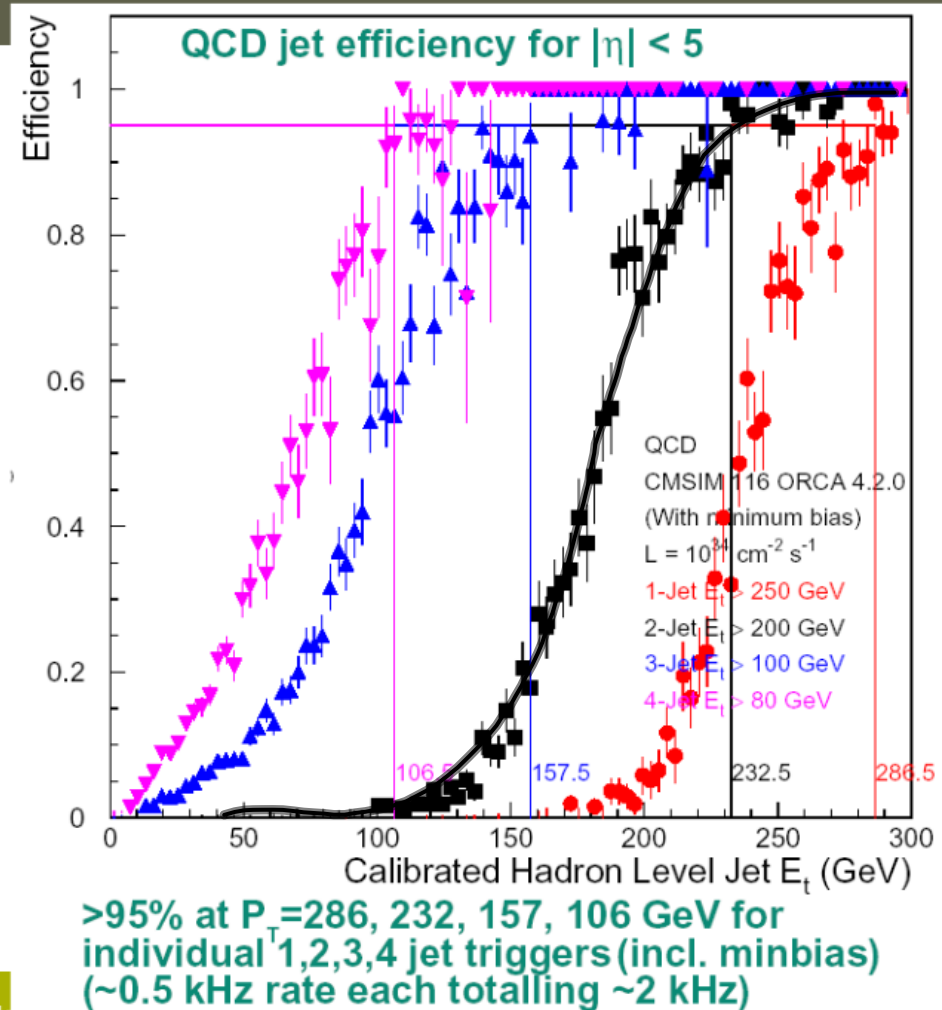
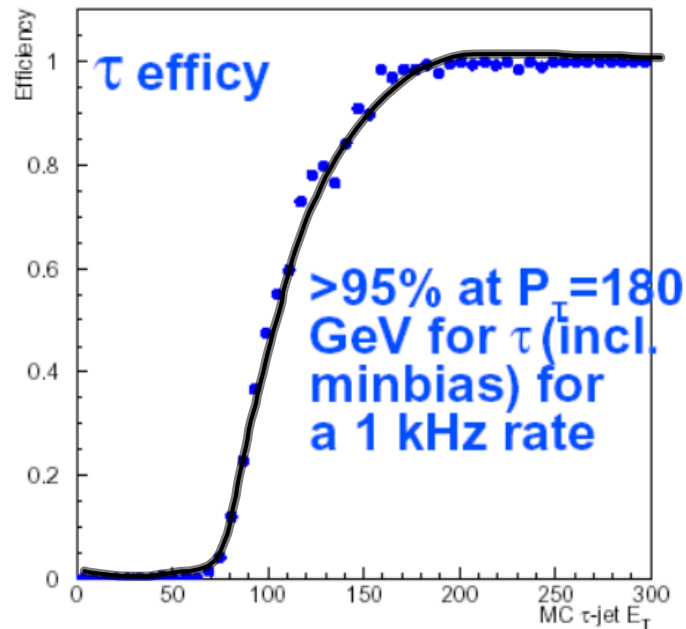

Muon system in CMS

- The muon system consists out of several complementary techniques for example to suppress the amount of "ghost" muons.
- Tracking algorithms are developed to construct the path of the muon candidate.
- The RPCs or Resistive Plate Chambers are dedicated to the trigger system due to their good time resolution to check the bunch crossing time. They are complemented with the high resolution provided by the DT and CSC.
- Hence we have two trigger subsystems which deliver independent information to the Global Muon Trigger.

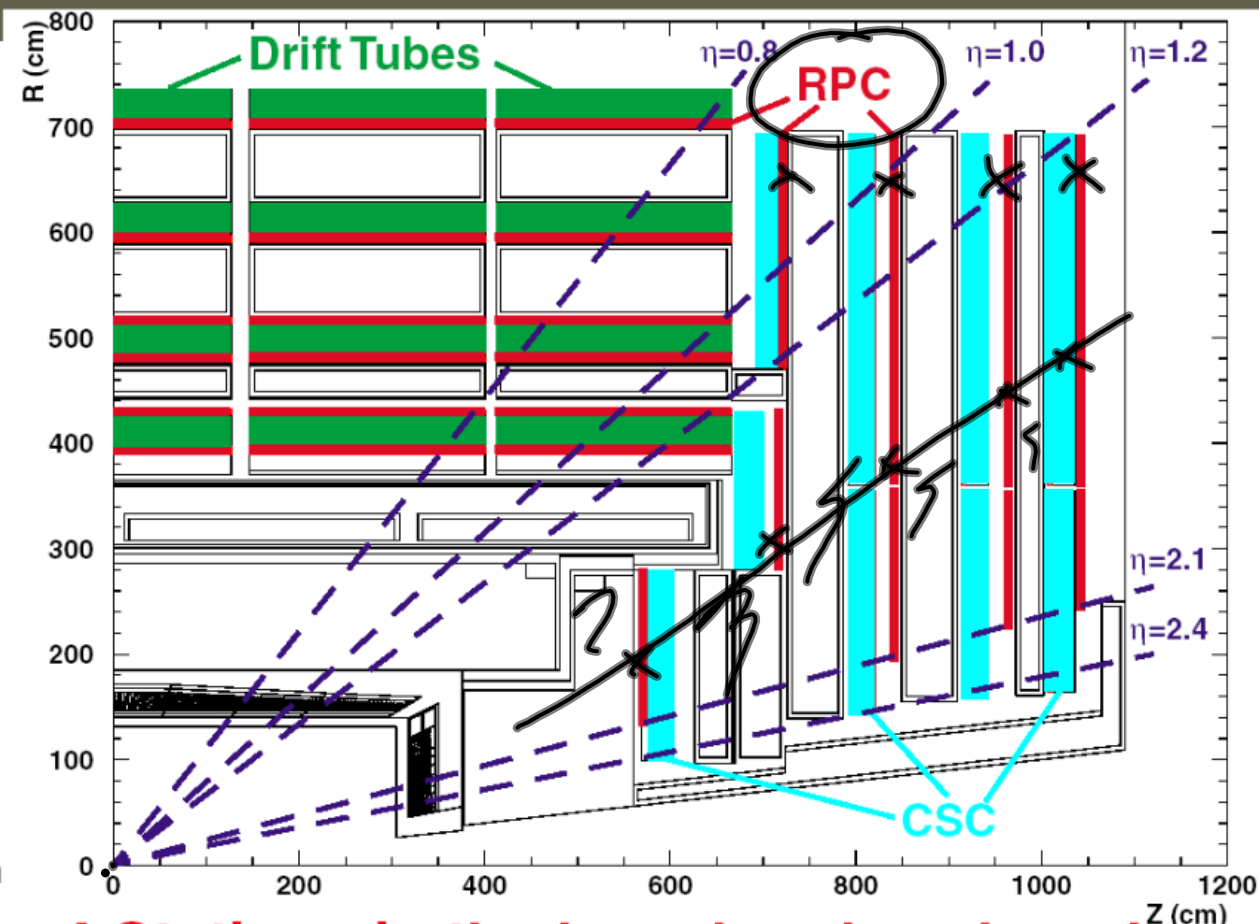

4 Stations in the barrel and each endcap

Level-1 muon trigger

Similar efficiency function for muons as for electrons

- For the muon Level-1 trigger several sub-detectors are combined to reduce the “ghost” muon candidates which are also triggering the system.
- At a threshold at $p_T > 25 \text{ GeV}/c$ a “ghost” rate of 0.07% and an efficiency for real muons of 90% is reached by taking the “AND” logic of the three sub-detectors (in $|\eta| < 2.4$).

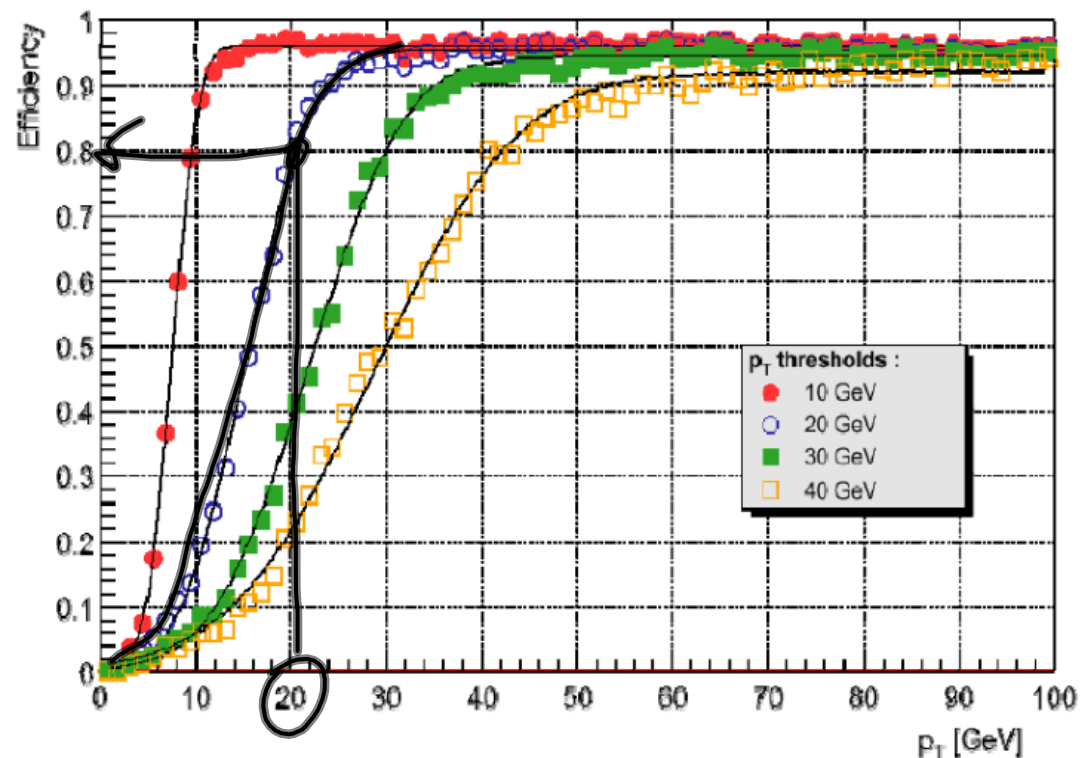

Level-1 trigger rates

na L1 → 100 kHz

The overall rate of online selected events is dropping fast with increasing thresholds. Need to tune the thresholds in order to fill the complete bandwidth of 100kHz with useful data events.

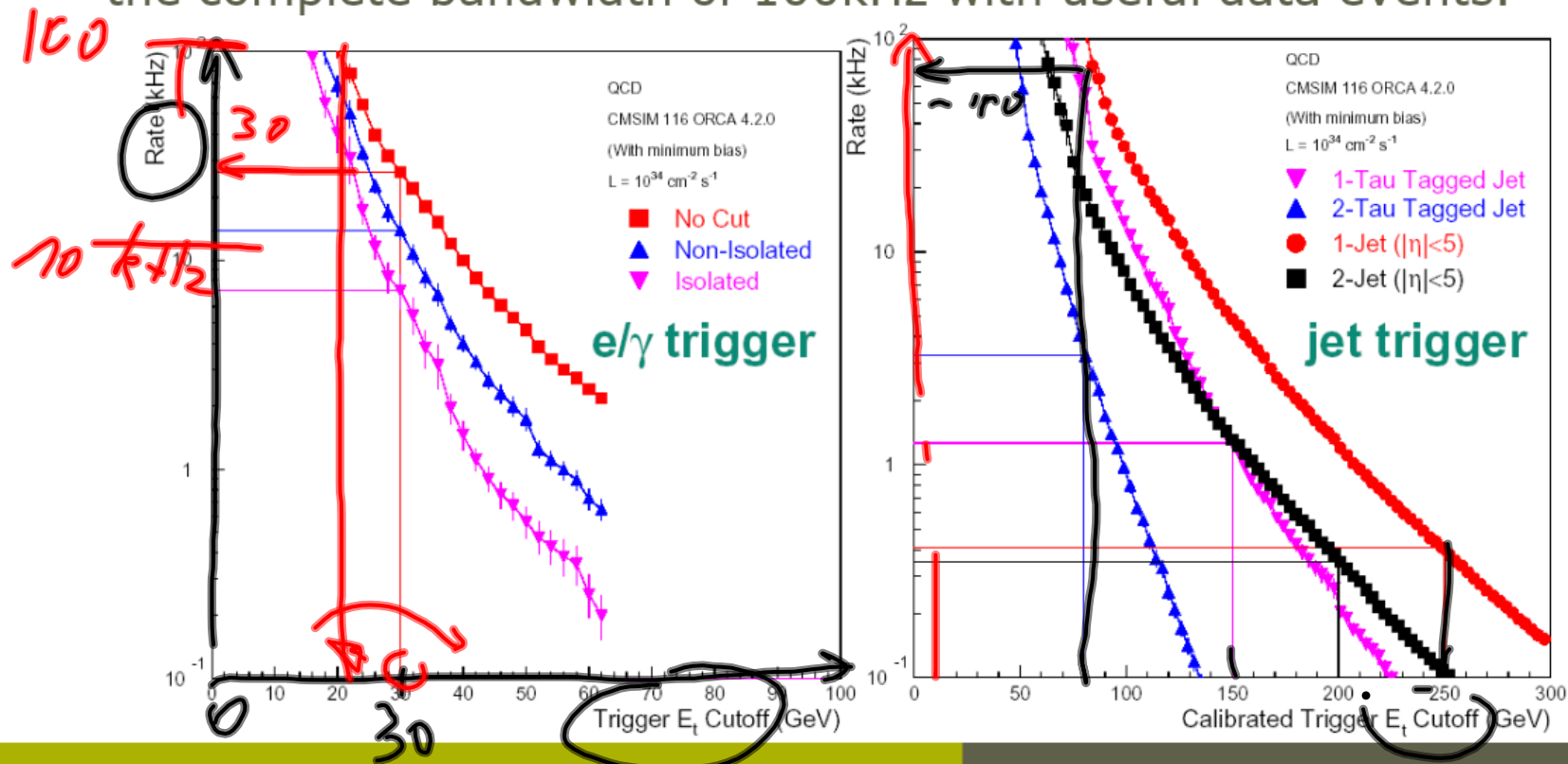

Level-1 trigger rates

Same challenges as at the Tevatron but higher energies, much higher luminosity & more interactions/crossing

Cut on E_T and p_T to discriminate against QCD backgrounds

- Higher E_T cuts than Tevatron needed
- More boost & don't lose efficiency

Examples of unrescaled high p_T trigger thresholds and rates:

	CDF L1		CDF L2		LHC L1	
	P_T Cut	Rate (HZ)	P_T Cut	Rate (Hz)	Pt Cut	Rate (Hz)
Single μ	4 GeV/c	280	12 GeV/c	25	20 GeV	10k
Single e	8 GeV	240	16 GeV	30	30 GeV	20k
Single γ	8 GeV	2400	18 GeV	60	30 (GeV)	20k
Single Jet	10 GeV	10K	90 GeV	10	300 (GeV)	200

CDF Rates for $2 \times 10^{32} \text{cm}^{-2} \text{s}^{-1}$, scaled from $3 \times 10^{31} \text{cm}^{-2} \text{s}^{-1}$

LHC rates for $10^{34} \text{cm}^{-2} \text{s}^{-1}$, from N. Ellis, LECC Workshop 2002 at Colmar

Global Level-1 trigger (CMS)

- The decision is based on the algorithm calculations and on the readiness of the sub-detectors and the DAQ system, which is determined by the Trigger Control System (TCS).

Level-1 Trigger Objects used for the decision:

- Jets**: 4 central, 4 forward, 4 tau-tagged & multiplicities
- Electrons**: 4 isolated, 4 non-isolated
- 4 muons**
- Missing E_T** and **total E_T**

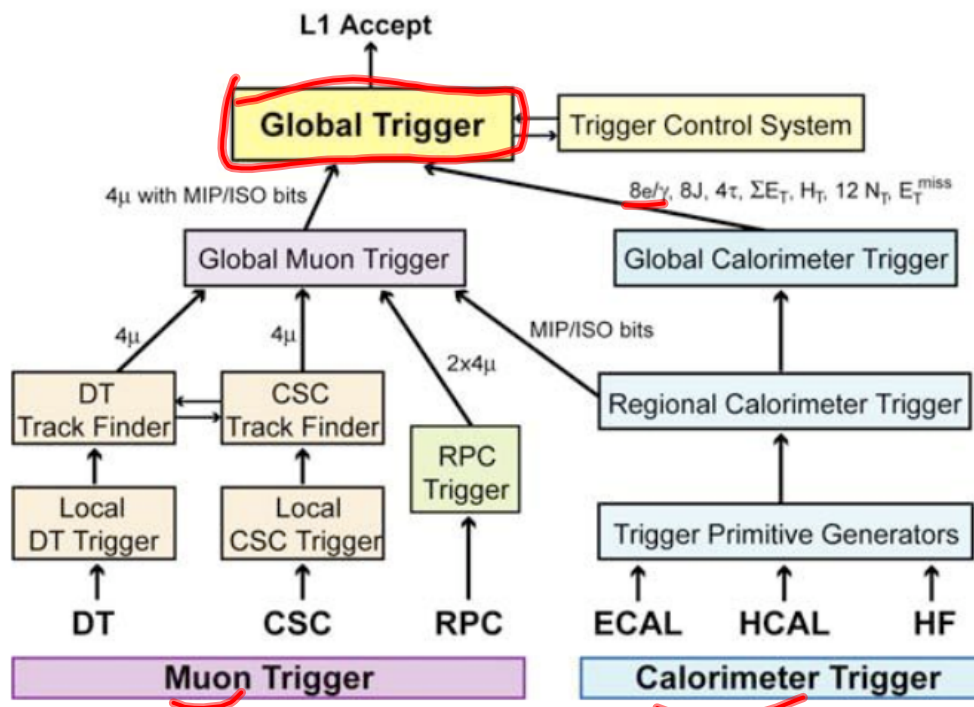

Level-1 is hardware

This selection requires hardware very near to the detector, hence new technologies or evolving technologies when we go to larger interaction rates (ASICs for radiation tolerant on-detector electronics and FPGAs which are more flexible, and communication technologies).



CDF L1&L2 Calorimeter Triggers: 12 9U Crates

ASIC: Application-Specific Integrated Circuits
FPGA: Field-Programmable Gate Arrays

**Zeus Calorimeter Trigger:
16 9U Crates**



Level-1 is hardware

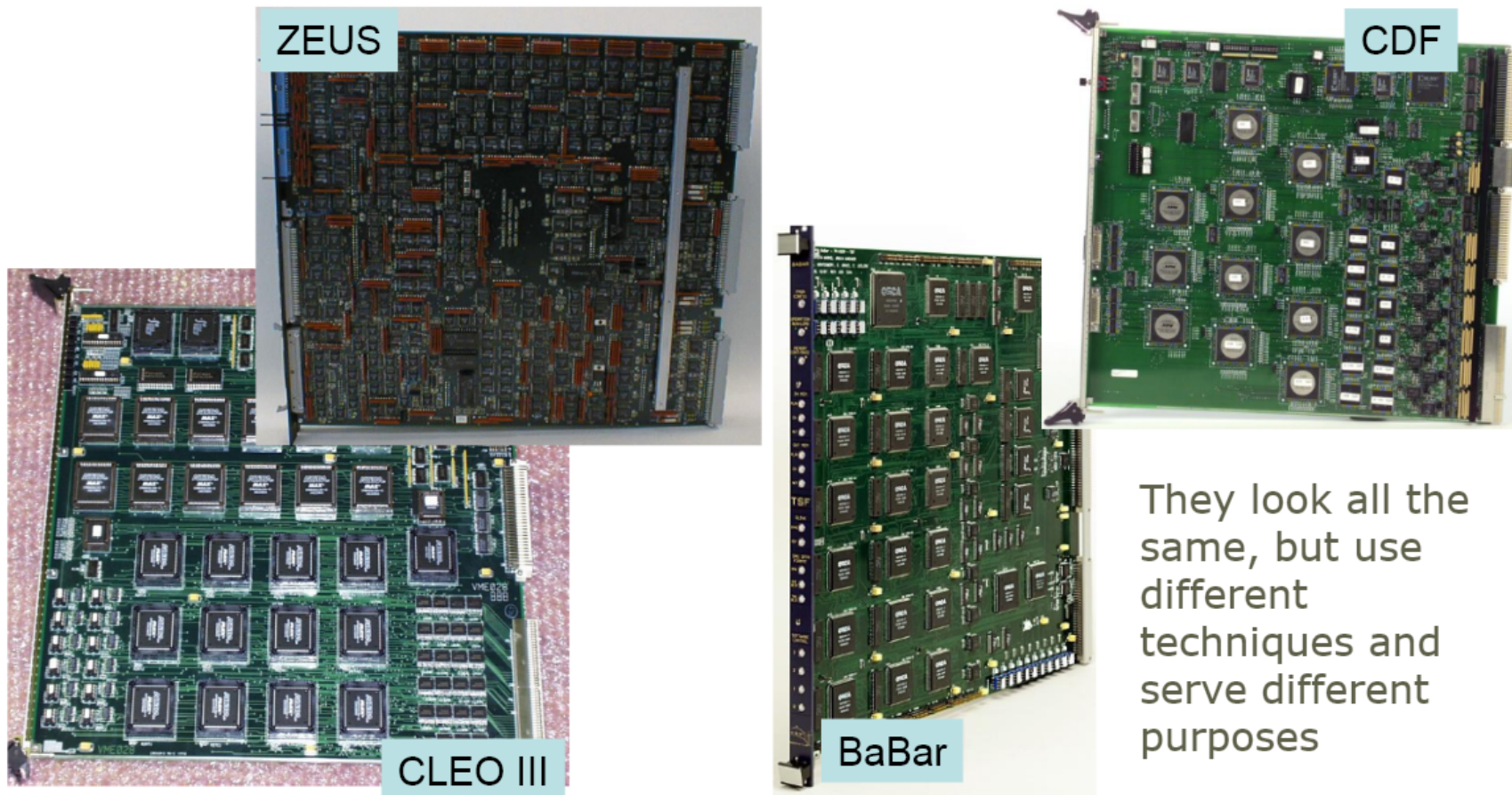

They look all the same, but use different techniques and serve different purposes

Trigger and DAQ trends

- Detectors become more and more complex, hence more and more read-out channels. Hence the event size in #byte is increasing demanding for larger bandwidths.
- The luminosity of the accelerators is increasing as we search for more and more rare processes. Hence the Level-1 rate in Hz is increasing demanding for faster processors.

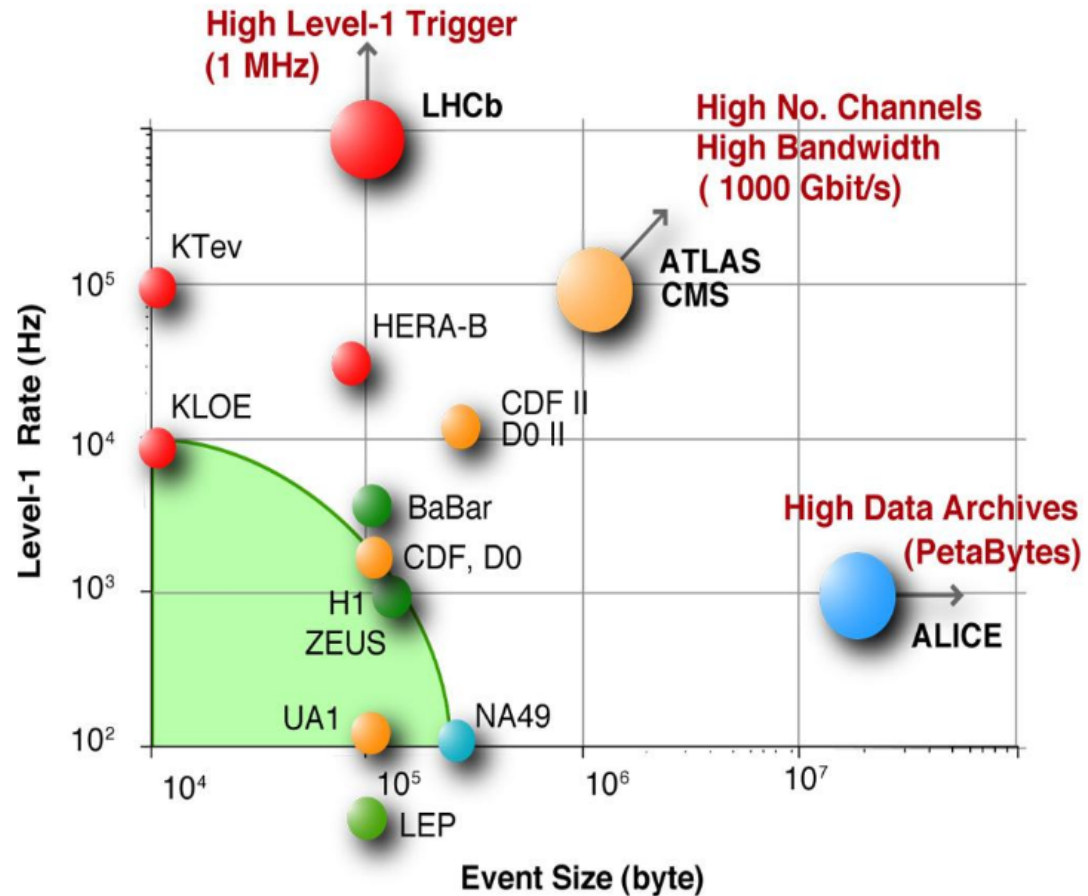

Level-1 summary

- First step in the online selection of the collision events to be saved on disk, based on hardware deployed very near to the detector.
- Large challenges for the LHC which deals with very high interaction rates (40MHz) and the detectors with a huge amount of read-out channels.
- Pipelined system for $3\mu\text{s}$ to decide on the event, therefore uses only part of the detector information (calorimeter & muon systems). Remember most of the time is spend on the transportation of the signal through cables.
- Reduce the rate from 40MHz to about 100kHz.
- Complex process to optimize the use of the bandwidth (which is limited) to the next trigger step. Tuning of threshold requirements for each stream (eg. 1 electron, 1 electron isolated, 2 muons, 3 jets, ...) results in a "trigger table" of the experiment. One should take into account the cross sections of the signal processes to be observed or discovered versus the rate of the background processes or the detector background consisting out of "fake" objects (eg. "ghost" muons).

DAQ system

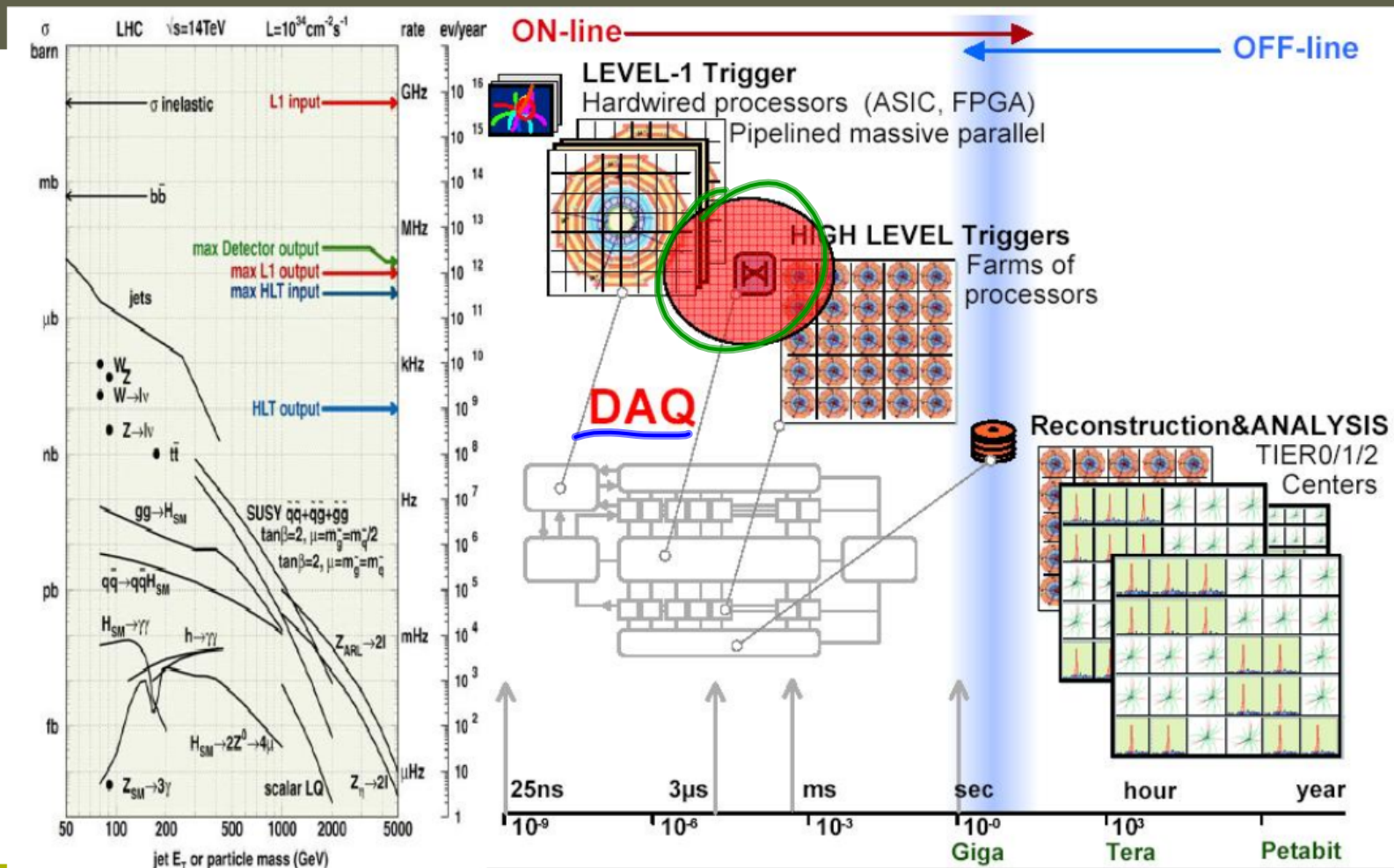

The “Event Builder”

- The main task of the DAQ system is to read the data corresponding to each event selected by the Level-1 trigger out of the detector Front-End Drivers (= the readout electronics specific to each type of detector). Beyond that to concentrate this into one data structure, called the physical “event”, and to forward this event to the filter farm for the final High Level decision if the event is to be written on disk or not for permanent storage. This complex system is called the “Event Builder”.
- The main parameters of this system is dictated by the physics program of the experiment
 - maximum Level-1 trigger rate of 100kHz
 - maximum rate after the High-Level Trigger of 100Hz
 - average event size of 1MB (dictated by the occupancy of the CMS detector channels)
- This is implemented in several stages.

Main view of the DAQ system

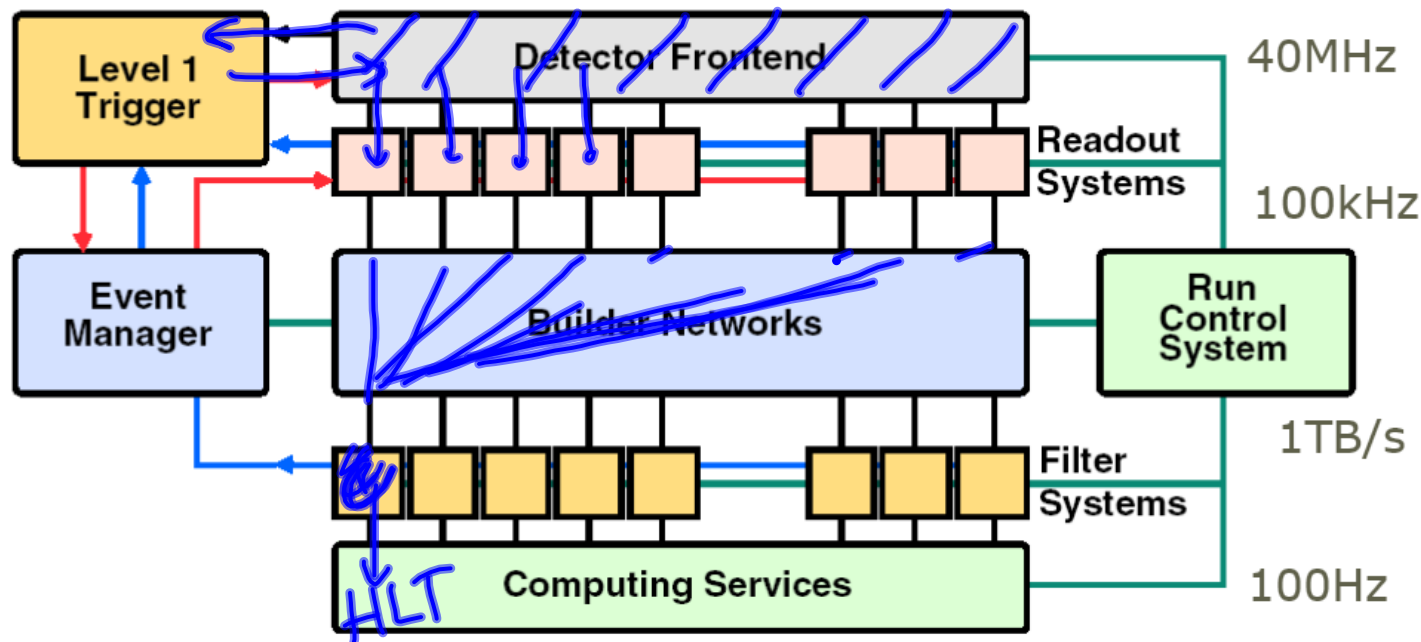

Collision rate	40 MHz	I-O units bandwidth (512+512)	400 MByte/s
LV1 Maximum trigger rate	100 kHz	Builder network (512x512 port)	≥ 500 Gbit/s
Average event size	≈ 1 Mbyte	Event filter computing power	$\approx 5 \cdot 10^6$ MIPS
Data production	\approx Tbyte/day	High Level Trigger acceptance	1 - 10 %
Event Flow Control	$\approx 10^6$ Mssg/s	Overall dead time	$\leq 2\%$

Data flow in proton collisions

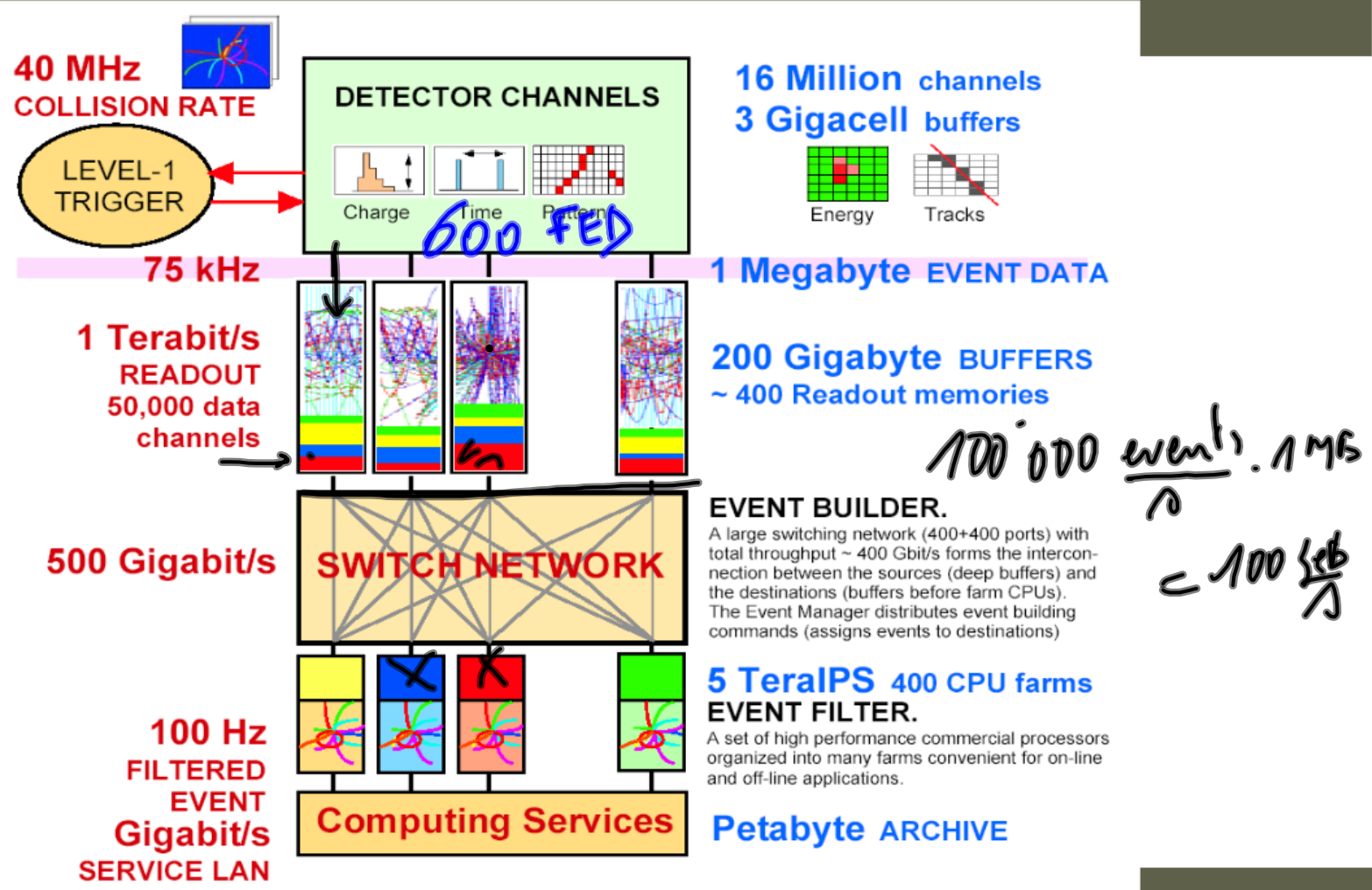

Main view of the DAQ system

From fragments of the event in different read-out systems, to full events.

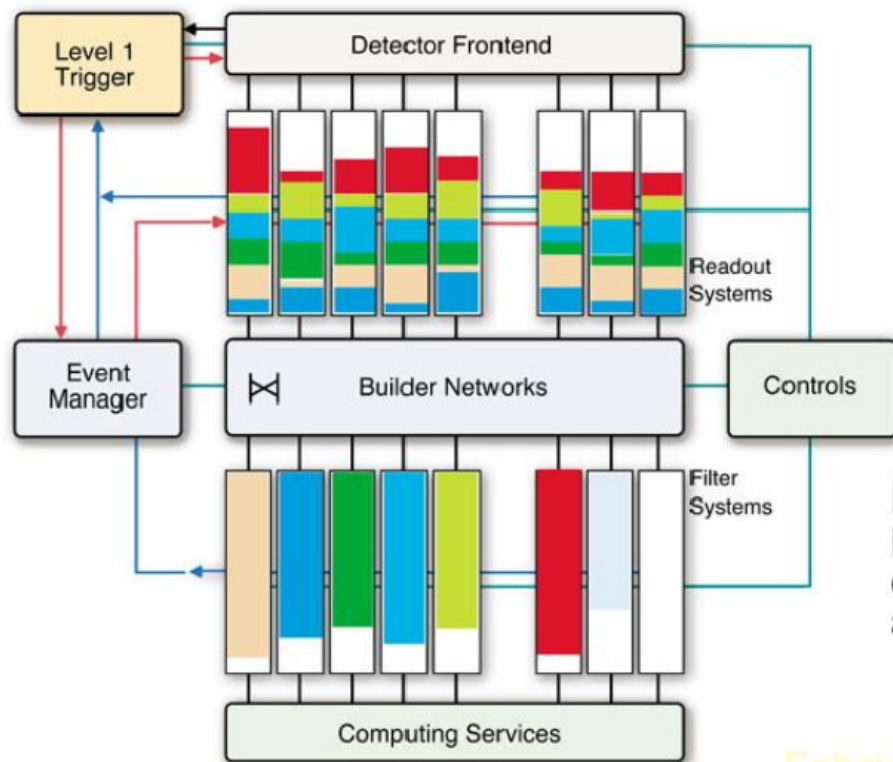

Event fragments :
Event data fragments are stored in separated physical memory systems

Full events :
Full event data are stored into one physical memory system associated to a processing unit

Hardware:
Fabric of switches for builder networks
PC motherboards for data Source/Destination nodes

Main view of the DAQ system

The factorization of the DAQ functions into four tasks facilitates the design. Deep buffers allow to match the widely different operating rates of the elements at each stage.

- Detector read-out (fragments)
- Event building (switch network)
- Selection stage (High Level Trigger or HLT)
- Analysis/storage stage (computing services)

For example the FED delivers at a rate of 100kHz (every $10\mu\text{s}$), but it takes the event building stage $1\text{MB}/2\text{Gb/s}=4\text{ms}$ to read the complete event.

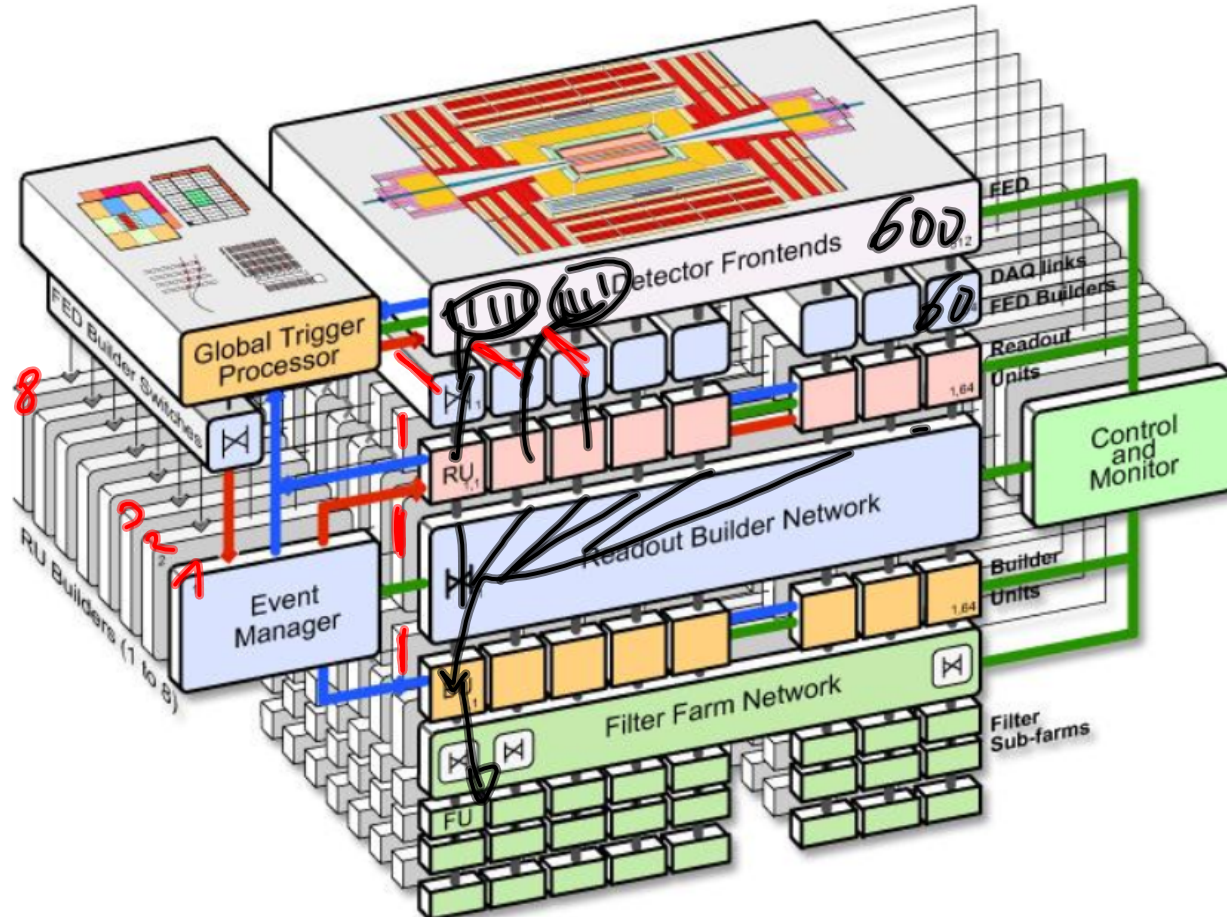

Scalability of the DAQ system

- The DAQ system is duplicated 8 times for which the deployment is staged (=flexibility). They are connected with a 8x8 switch network (FED Builder), hence for each event in the system there are 8 potential destinations as far as the Front-End information is concerned.
- Basically one extra layer of switches allows to increase the DAQ performance when duplicating the full system which can come whenever the physics program requires.

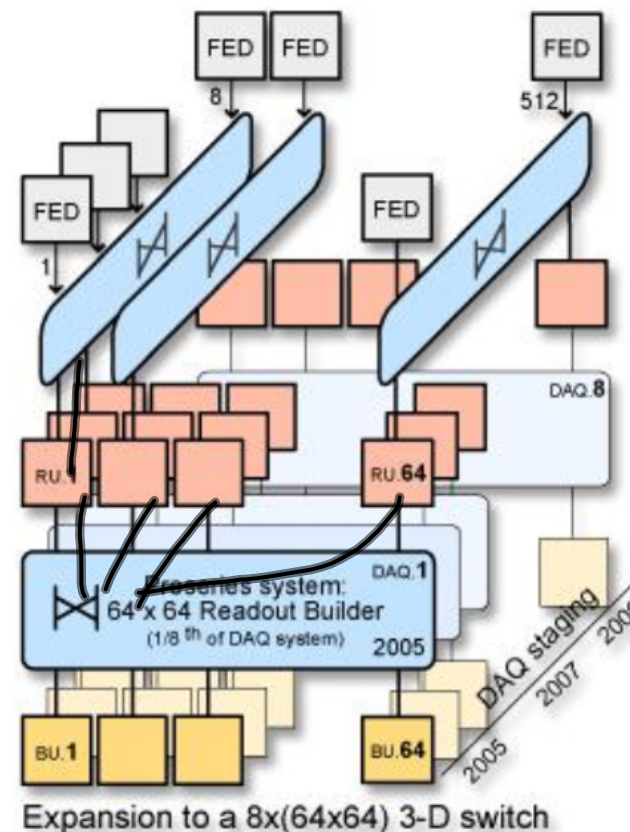
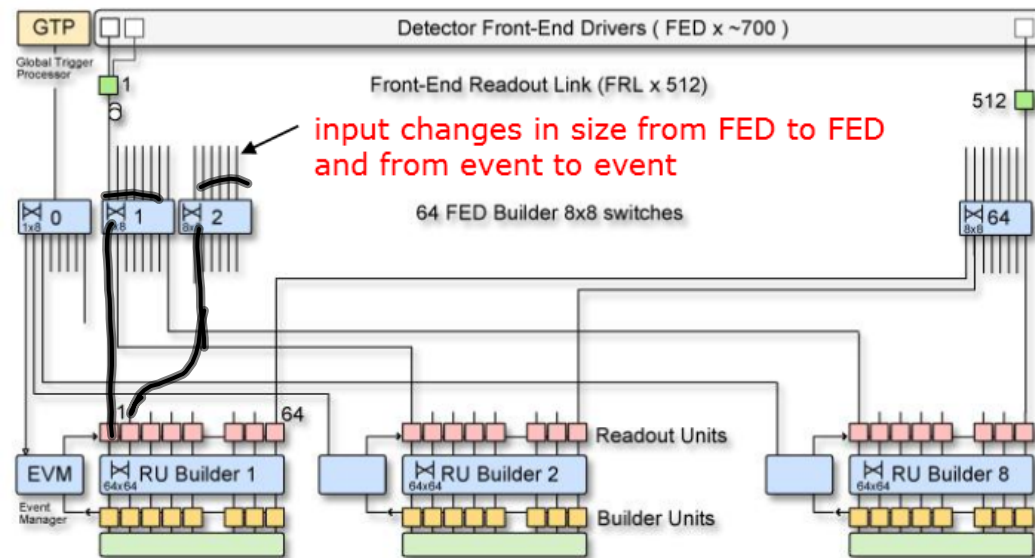

FED Builder specifications

- The main functions of the FED Builder are:
 - transport the fragments from the underground area to the surface
 - assemble event fragments of variable size from some ~700 FEDs into 64 super-fragments of roughly equal size (16kB each)
 - these super-fragments are given one of the 64 Readout Unit Builders in a particular DAQ slice

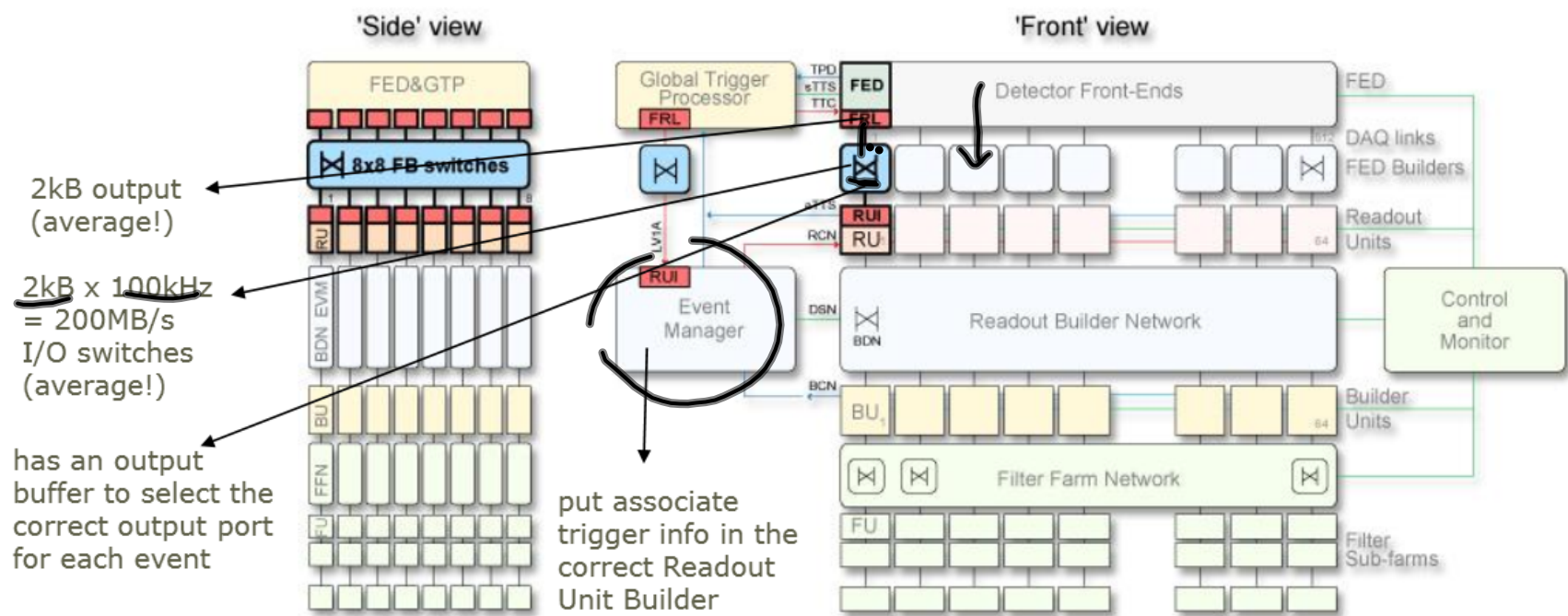

Main view of the DAQ system

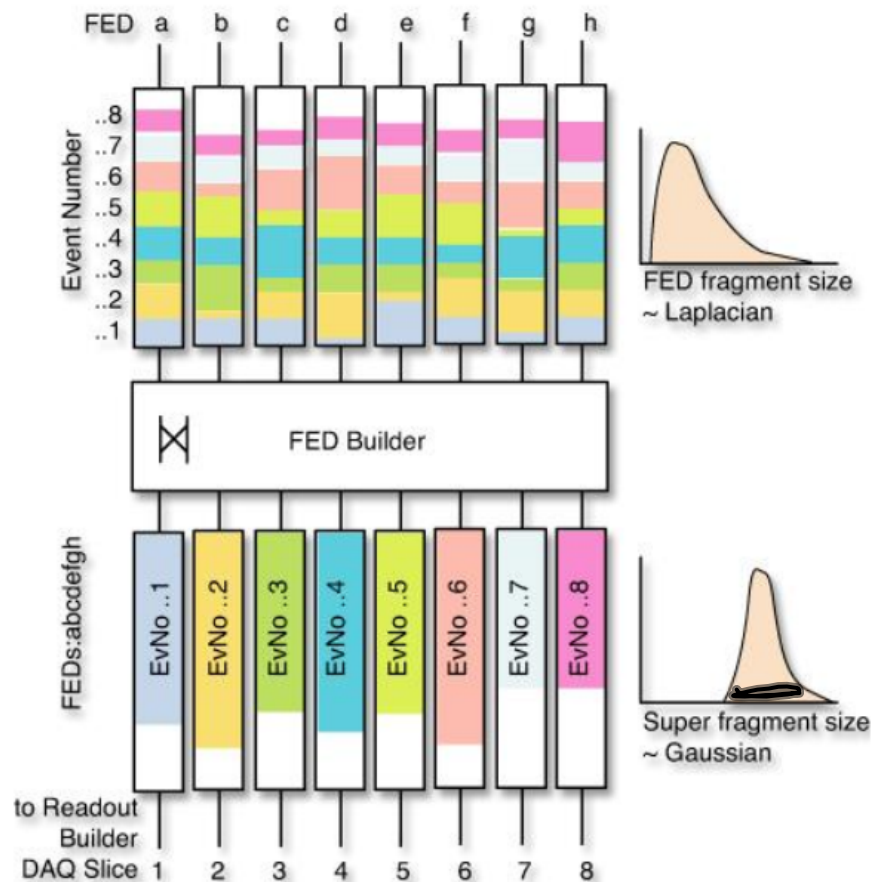

Close-up illustration between the FED and the Readout Units :

- The size of the fragments of the event which are being formed is increasing (FED fragments of 2kB to super-fragments of 16kB on average).
- The amount of links is being reduced.

Readout Unit Builder

Via a network of switches the event is built from the fragments deliver from the Front-End electronics of the detectors. At a rate of 12.5kHz ($= 100\text{kHz} / 8 \text{ DAQ slices}$) and a mean event size of 16kB from 64 RUs = 1MB, the total sustained throughput of the switch fabric should be about 200MB/s (including event-by-event fluctuations).

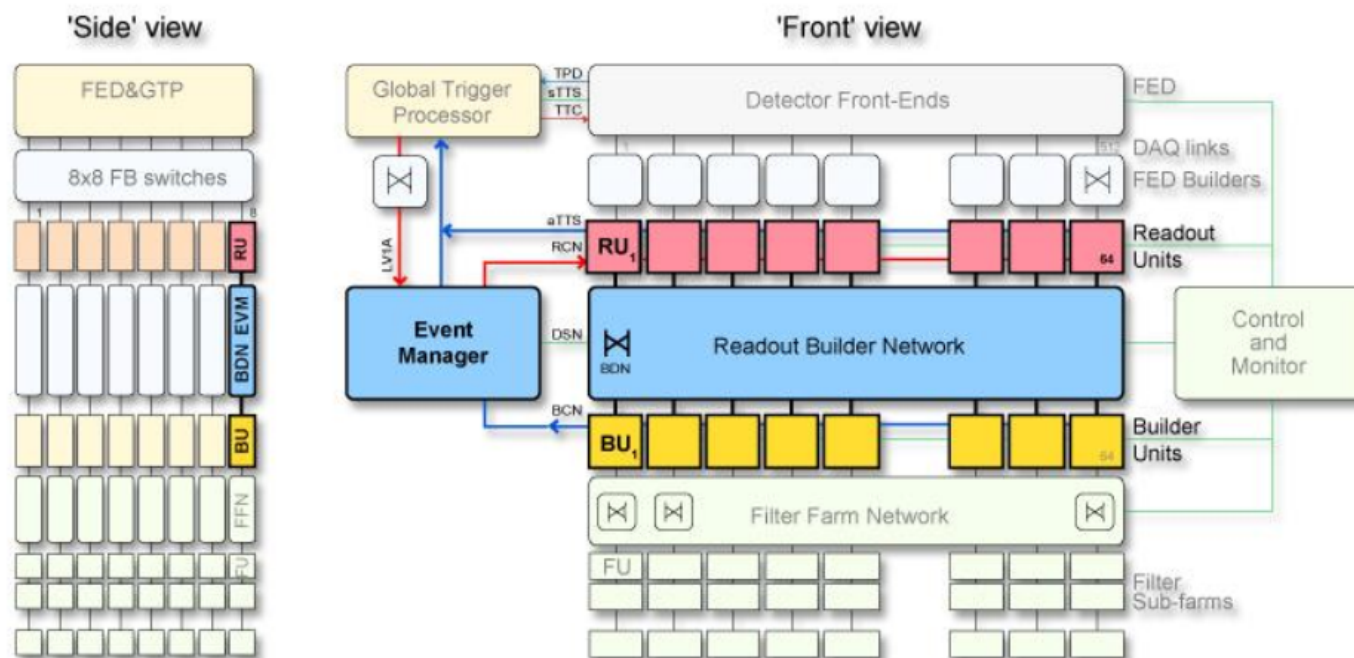

High-Level Trigger

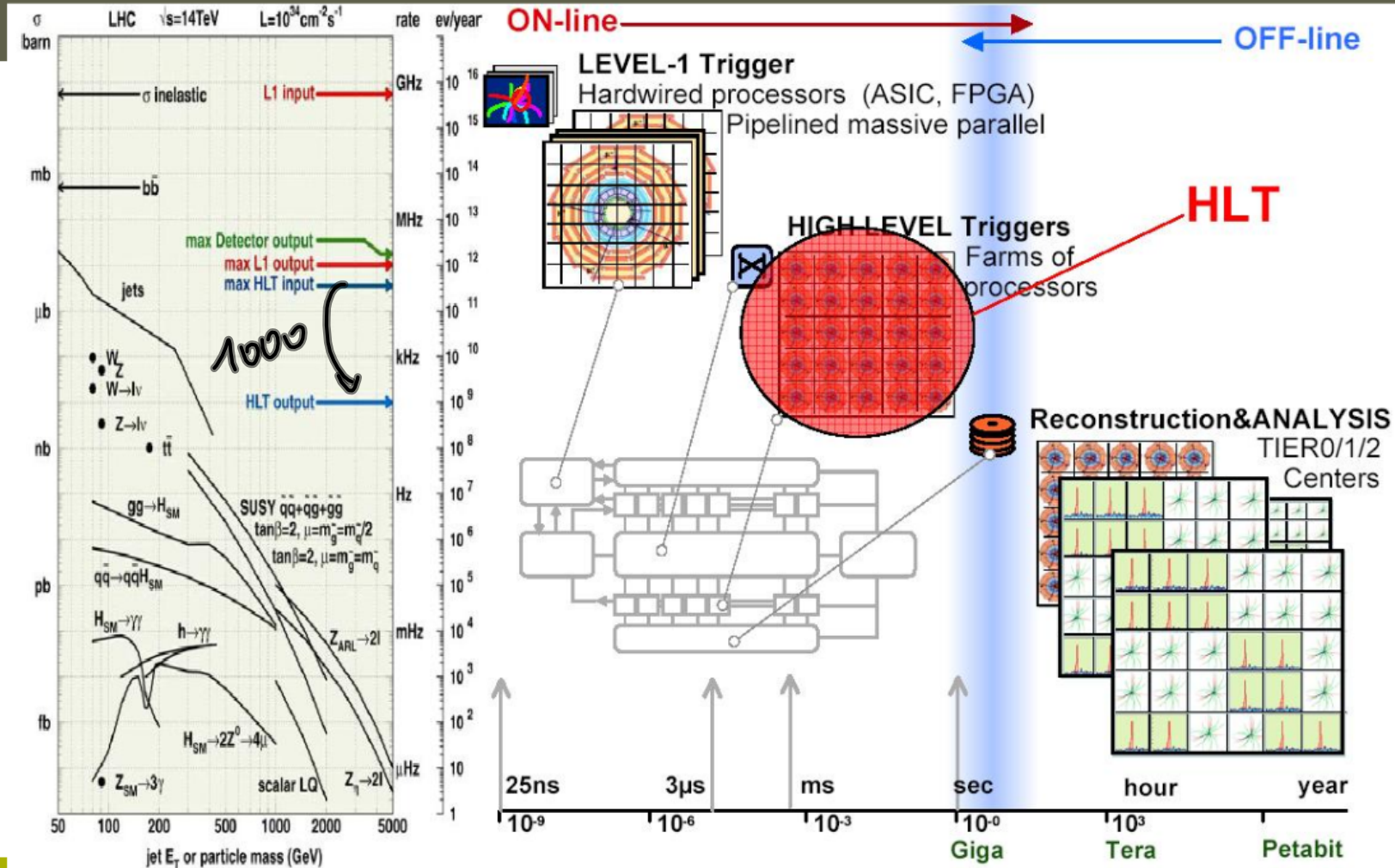

High-Level Trigger

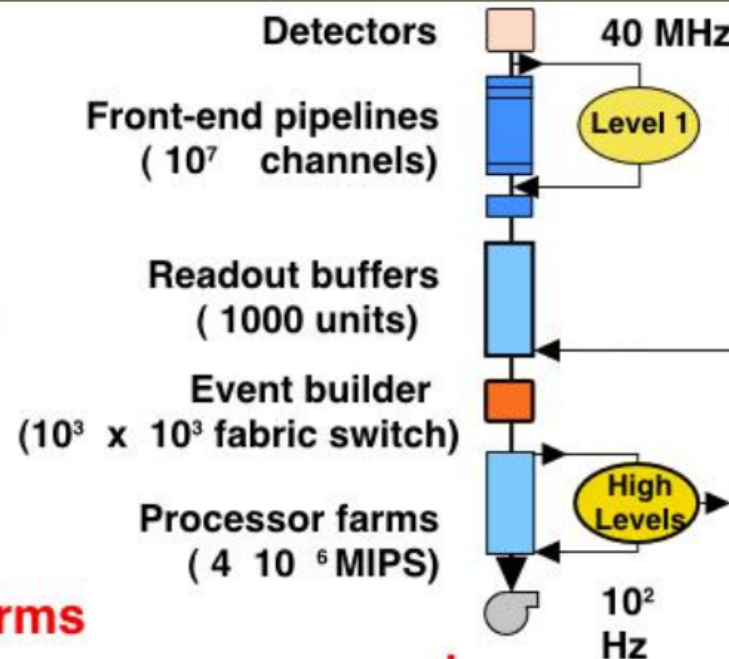
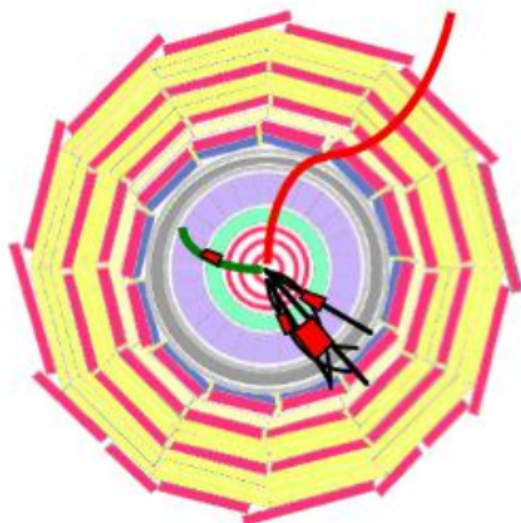

High level triggers. CPU farms

- Finer granularity precise measurement
- Clean particle signature (π^0 - γ , isolation, ...)
- Kinematics. Effective mass cuts and topology
- Track reco and matching, b, τ -jet tagging
- Full event reconstruction and analysis

**Successive improvements :
background event filtering,
physics selection**

HLT table

- With each object or multi-object topology an HLT stream is defined based on software loaded on a multi-processor PC farm.
- The tuning of the bandwidth to be allocated to which HLT stream is guided by the physics program of the experiment (eg. Higgs boson, SUSY, ... but also calibration issues).
- It is important to check the trigger efficiency of the signal processes of interest and to adapt the trigger thresholds accordingly. Most of the new physics phenomena of interest are created at larger mass scales and therefore give objects at large transverse momenta.
- At this point we use all relevant information in the event and the level of complexity of the HLT algorithms define the scale of the computing farm.
- Next course on reconstruction tools.

Referentie:

<http://arxiv.org/ftp/hep-ex/papers/0512/0512077.pdf>

HLT table for low luminosity

Trigger	Threshold (GeV or GeV/c)	Rate (Hz)	Cumulative Rate (Hz)
inclusive electron	29	33	33
di-electron	17	1	34
inclusive photon	80	4	38
di-photon	40, 25	5	43
inclusive muon	19	25	68
di-muon	17	4	72
τ -jet * E_T	86 * 65	1	73
di- τ -jets	59	3	76
1-jet * E_T	180 * 123	5	81
1-jet OR 3-jets OR 4-jets	657, 247, 113	9	89
electron * τ -jet	19 * 45	0.4	89.4
muon * τ -jet	15 * 40	0.2	89.6
inclusive b-jet	237	5	94.6
calibration and other events (10%)*		10	105
TOTAL			105

High-Level Trigger

The amount of time needed to select the HLT object and the rate of these events after Level-1 trigger. This gives an estimate on how much computers are needed in the HLT farm for 15.1kHz of Level-1 trigger rate (calculations are of course evolving with the evolution of the computer processors). Today it results in about 2000 CPU's for the start up of the LHC.

Physics Object	CPU time per Level-1 event (ms)	Level-1 Trigger rate (kHz)	Total CPU time (s)
<u>electron/photon</u>	160	4.3	688
<u>muon</u>	710	3.6	2556
tau	130	3.0	390
jets and E_T	50	3.4	170
electron + jet	165	0.8	132
<i>b</i> -jets	300	0.5	150

Summary of first part

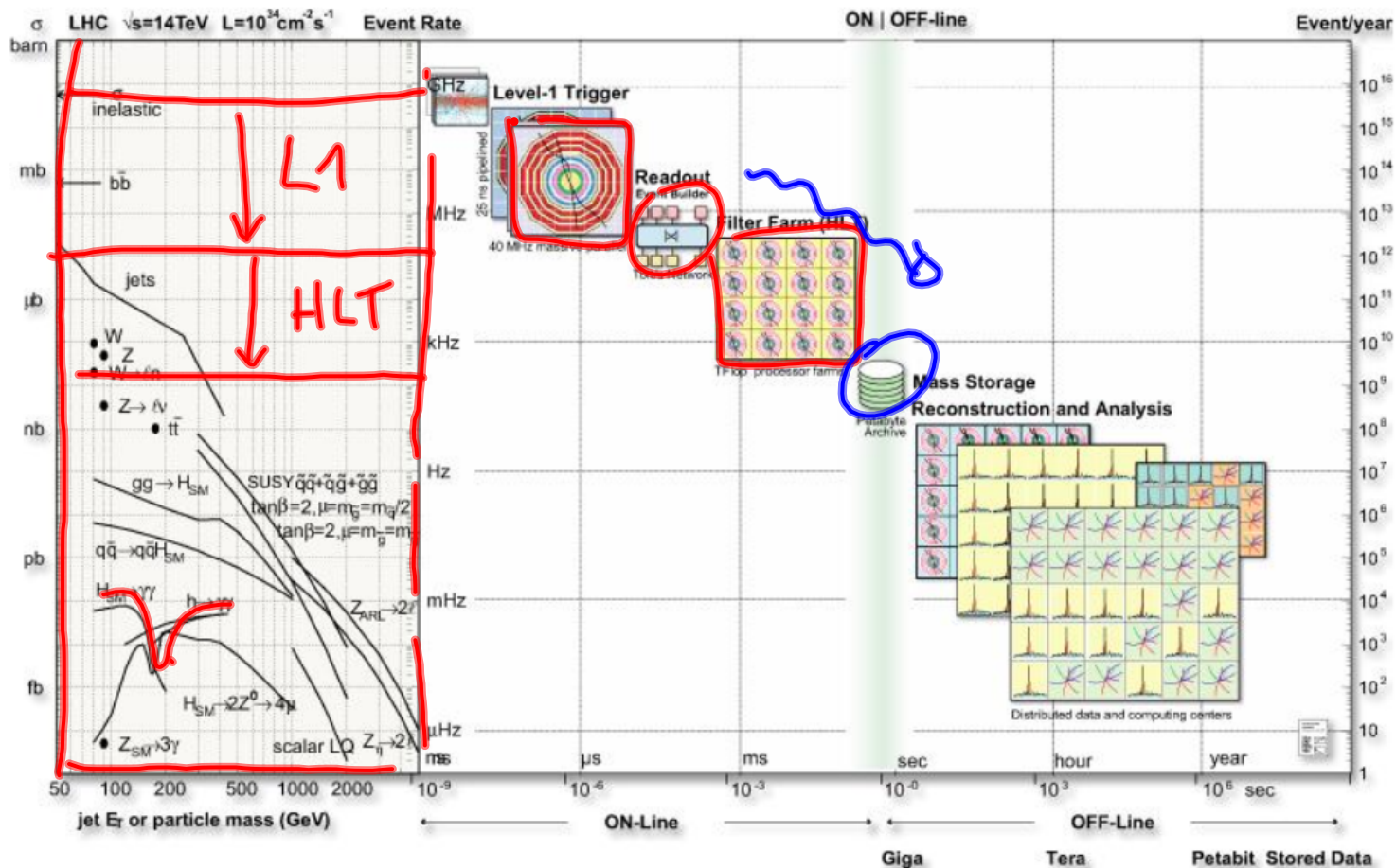

Summary of first part

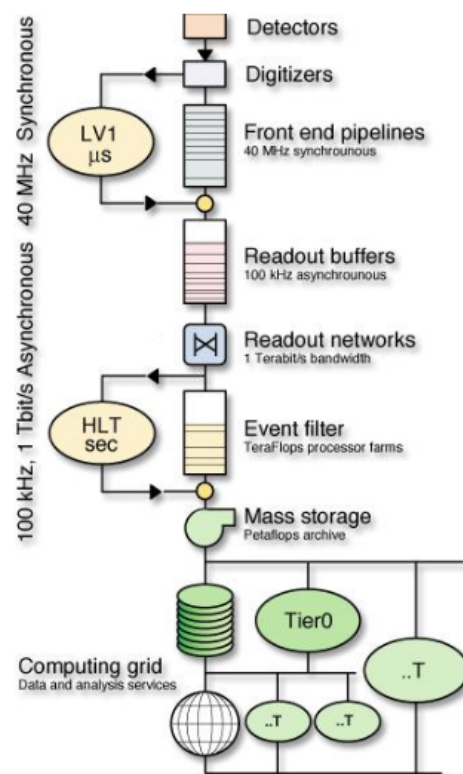

- A modern particle physics detector has millions of readout channels and therefore hundreds of Front-End Driver. On top of this the event rate is very high.
- Hence large amount of data has to be processed in a very short time.
- Only a small fraction of the events can be stored on disk, hence very quick a decision has to be made on a complex multi-channel event.
- The online data reduction is performed in several steps: electronics very close to the detector (Level-1 Trigger), a large bandwidth transfer system to built the event (DAQ system) and a more complex layer (High-Level Trigger)

Summary of first part

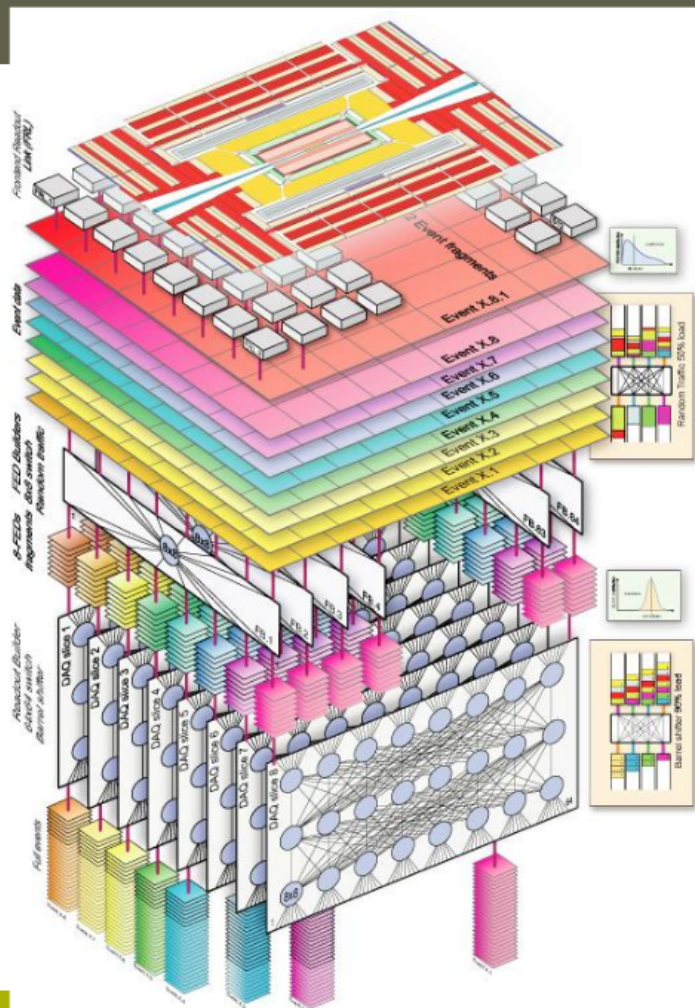

- From signals in the FED's to an event in my ROOT file...
- The DAQ of such experiments is very complex and requires specific electronics and a multi-layer approach to built the events
- The ideas can be applied for other experiments, but the implementation is specific for each (sub-)detector

Summary of first part

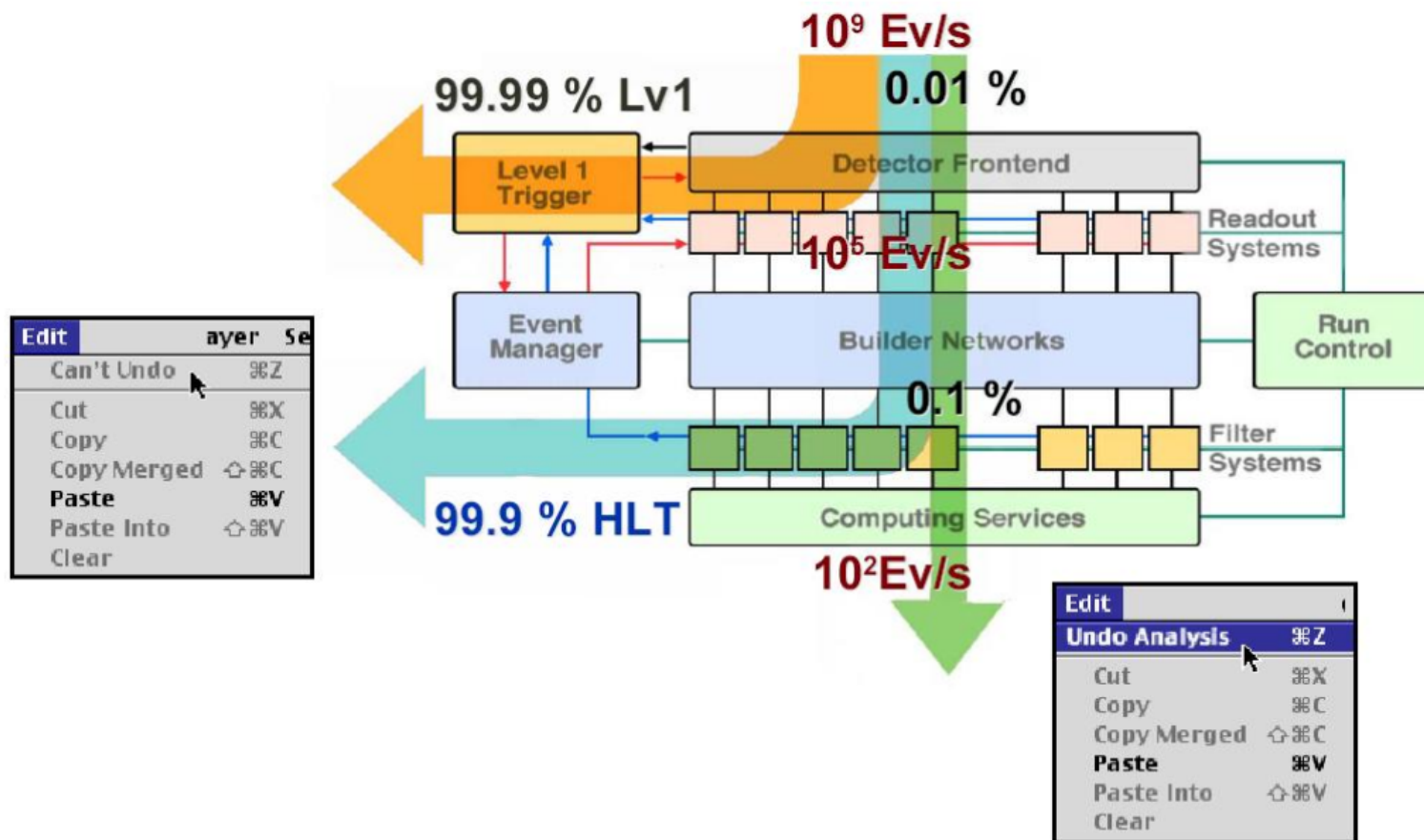

End of Part I

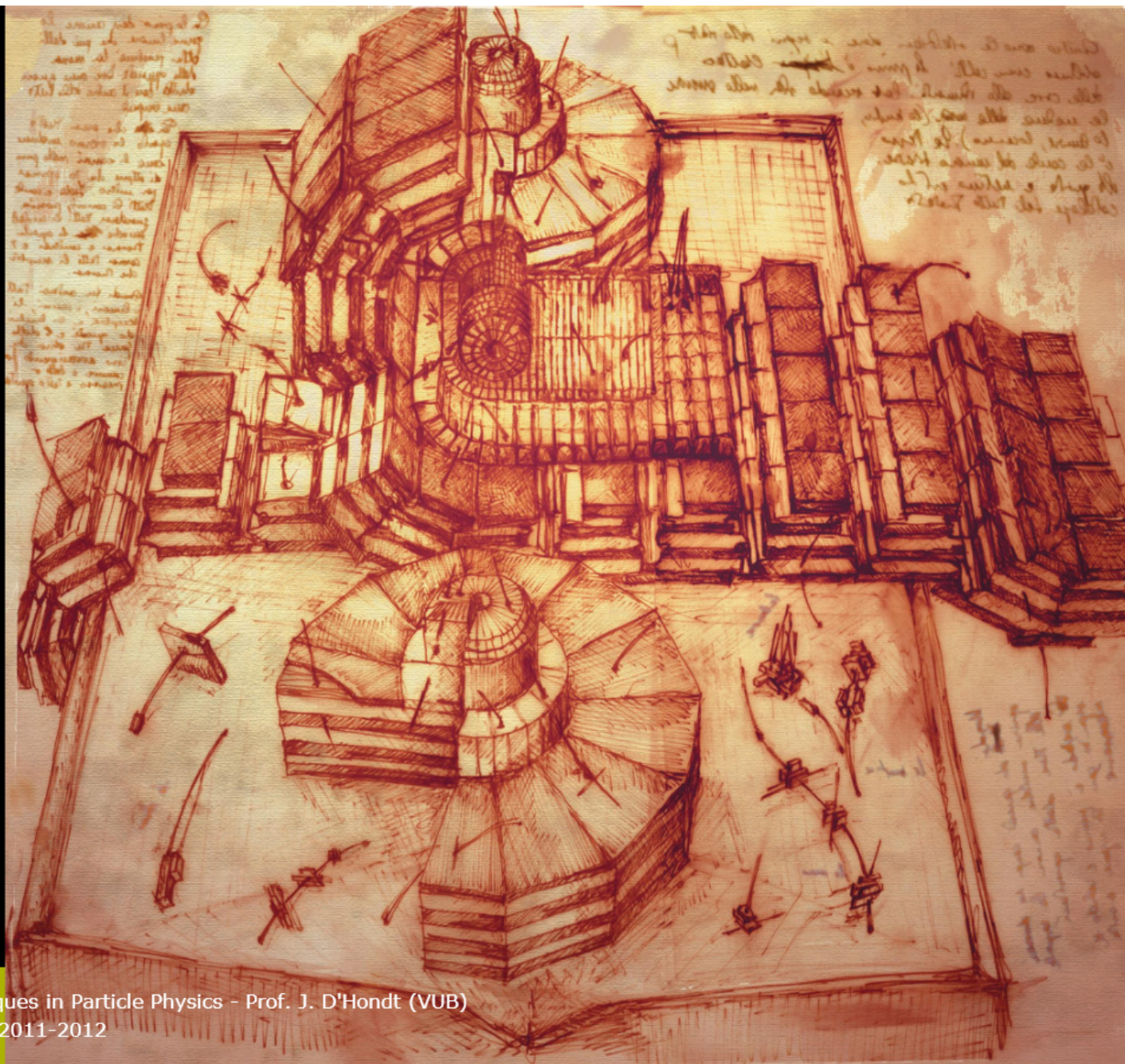

Experimental Techniques in Particle Physics - Prof. J. D'Hondt (VUB)
Master Level Course 2011-2012